

LGPOWER™

LC-M24-FHD-165-C

GAMING MONITOR



BEDIENUNGSANLEITUNG

INHALT

1. Sicherheitshinweise
2. Wartung
3. Verpackungsinhalt
4. Produktübersicht
5. Standfußinstallation
6. Wandmontage
7. Anschließen der Kabel
8. Grundbedienung
9. Leuchtanzeige
10. OSD-Menü
11. Eco-Modi und Gameplus-Umschaltung
12. Technische Daten

1. Sicherheitshinweise

Setzen Sie den Monitor nicht einer feuchten Umgebung, Regen oder anderen Flüssigkeiten aus.

Öffnen Sie nicht das Monitorgehäuse! Stromschlaggefahr durch Hochspannung innerhalb des Monitors!

Betrieb:

- Halten Sie den Monitor von direkter Sonneneinstrahlung und anderen Wärmequellen (z.B. Heizungen) fern.
- Halten Sie jegliche Flüssigkeiten vom Monitor fern.
- Achten Sie darauf, dass nichts in die Belüftungsöffnungen fallen kann.
- Blockieren Sie nicht die Belüftungsöffnungen, um eine Überhitzung zu vermeiden.
- Schlagen Sie nicht gegen den Monitor und lassen Sie das Gerät nicht fallen.

2. Wartung

ACHTUNG: Ziehen Sie das Netzkabel aus der Steckdose, bevor Sie den Monitor reinigen.

- Zum Reinigen des Bildschirms benutzen Sie ein weiches Tuch, das Sie leicht (!) mit destilliertem Wasser angefeuchtet haben.
- Verwenden Sie am besten spezielle Reinigungstücher für Bildschirme.
- Benutzen Sie keinesfalls Benzin, Verdünnung, sehr saure oder alkalische Mittel, Scheuermittel oder Druckluft!
- Ungeeignete Reinigungsmittel können den Monitor beschädigen und unschöne Schlieren auf dem Bildschirm und dem Gehäuse hinterlassen.
- Ziehen Sie den Netzstecker, wenn Sie den Monitor längere Zeit nicht benutzen.
- Halten Sie den Monitor von sämtlichen Flüssigkeiten, Staub und Feuchtigkeit fern.
- Falls der Monitor mit Flüssigkeiten in Berührung gerät, wischen Sie ihn sofort mit einem Tuch trocken.
- Falls Flüssigkeiten in die Belüftungsöffnungen eindringen, ziehen Sie sofort den Netzstecker, benutzen den Monitor nicht mehr. Bitte wenden Sie sich an einen professionellen Servicetechniker.

Rechtliche Hinweise:



HDMI, das HDMI-Logo und „High-Definition Multimedia Interface“ sind Marken oder eingetragene Marken der HDMI Licensing Administrator LLC in den USA und anderen Ländern.

3. Verpackungsinhalt



1 x Monitor

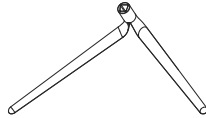

1 x Ständerbasis

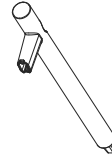

1 x Ständerschaft

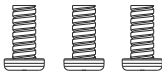

Schraube (3 x PM4 x 12)
(für Ständermontage)

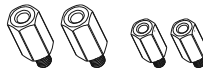

Sechskantschraube
(2 x M4 x 12/ 2 x M4 x 9 mm)
(zur Wandmontage)



1 x Schaftabdeckung

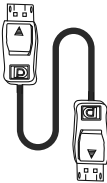

1 x DP-Kabel

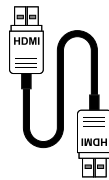

1 x HDMI-Kabel

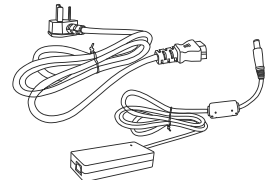

1 x Netzkabel
1 x Netzteil

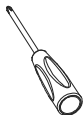

1 x Schraubendreher



1 x Bedienungsanleitung

Eventuell sind zusätzliche Schrauben als Ersatz beigelegt.

4. Produktübersicht

4.1 Tasten am Monitor

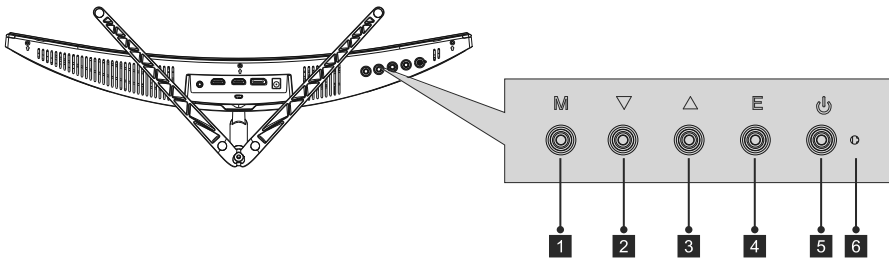

1. Menütaste: Ruft das OSD-Menü auf und greift auf die Untermenüs zu.
2. Abwärtstaste: Navigiert in den Menüs nach oben.
3. Aufwärtstaste: Navigiert in den Menüs nach unten.
4. Verlassen-Taste: Zum Verlassen des Menüs drücken.
5. Ein-/Aus-Taste: Schaltet den Monitor ein und aus.
6. LED-Anzeige: Zeigt den Monitorstatus durch unterschiedliche Farben an.

4.2 Monitoranschlüsse

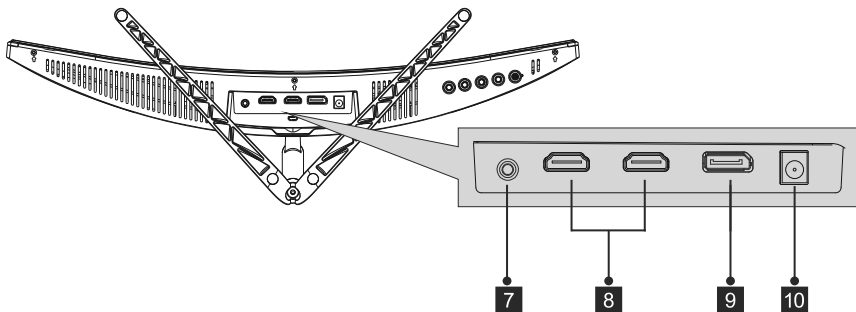

7. Audioausgang: Verbinden Sie Ihren Kopfhörer oder Lautsprecher zur Wiedergabe der Audiosignale vom Computer.
 8. HDMI-Anschlüsse: Verbinden Sie ein HDMI-Kabel mit einem dieser Anschlüsse und dem HDMI-Anschluss des Computers (z.B. Grafikkarte oder Mainboard).
 9. DP-Anschluss: Verbinden Sie das DisplayPort-Kabel mit diesem Anschluss und dem DisplayPort-Anschluss des Computers (z.B. Grafikkarte oder Mainboard).
 10. Netzanschluss: Verbinden Sie das Netzkabel mit dem Monitor und einer Steckdose.
-  Falls Sie andere DP- oder HDMI-Kabel nutzen möchten, achten Sie bitte darauf, dass diese die aktuellsten Standards unterstützen. Dadurch werden bestmögliche Bildqualität und Bildwiederholfrequenz erzielt.

5. Standfußinstallation

☑ Belassen Sie die Schaumpolsterung unter dem Monitor, während Sie den Ständer anbringen.

1. Öffnen Sie die Verpackung und nehmen Sie das Produkt mit dem Schaumstoff heraus. Platzieren Sie es vorsichtig auf einem Tisch und decken Sie den Bildschirm ab.

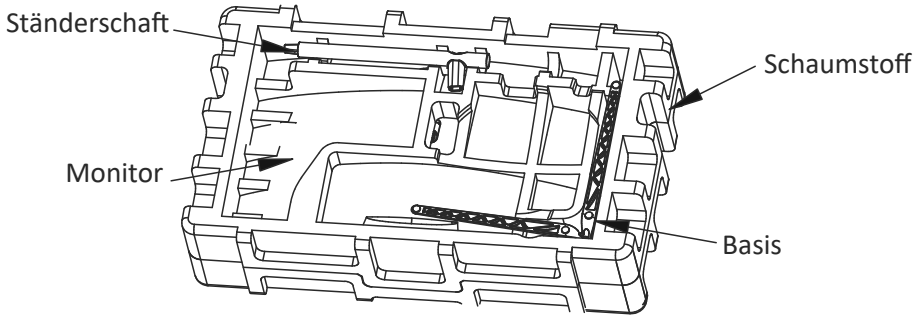

2. Drücken Sie die Basis in den Schaft und montieren Sie sie mit einer M4-Schraube.

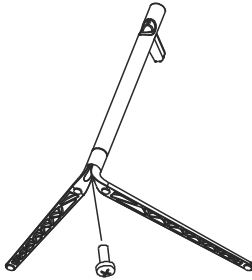

3. Entfernen Sie den Schutz von der Oberseite des Bildschirms und stellen Sie den Monitor auf einen flachen Untergrund.

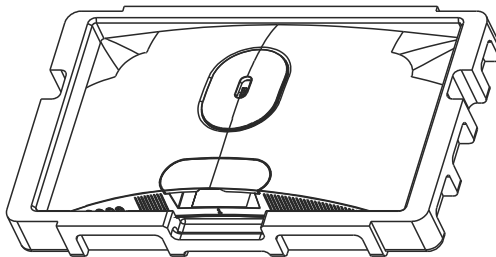

4. Bringen Sie den Ständer mit einer M4-Schraube am Monitor an.

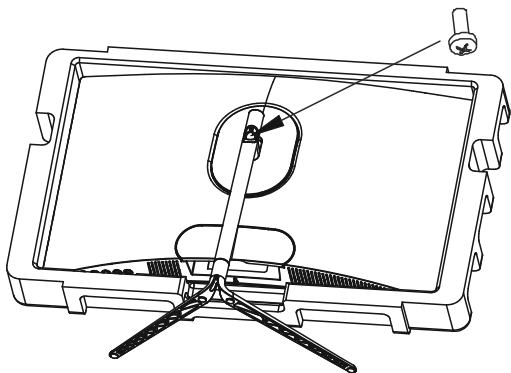

5. Montieren Sie die Schaftabdeckung zum Abdecken der Schraube am Schaft.

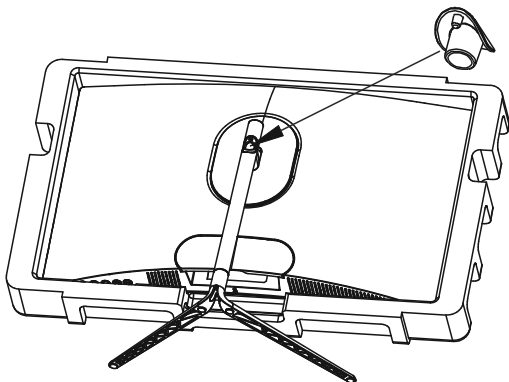

6. Damit ist die Ständerinstallation abgeschlossen.

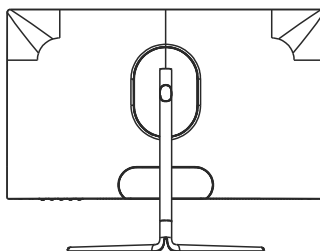
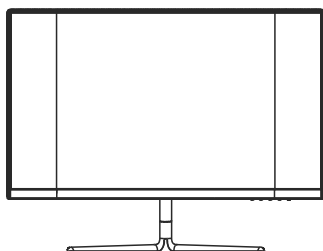

-  Lassen Sie das Schaumstoffteil während des Aufstellens am Monitor.
Berühren Sie den Bildschirm nicht. Andernfalls können Schäden auftreten.

6. Wandmontage

1. Öffnen Sie die Verpackung und nehmen Sie das Produkt mit dem Schaumstoff heraus. Platzieren Sie es vorsichtig auf einem Tisch und decken Sie den Bildschirm ab.

Drücken Sie die Freigabetaste zum Entfernen der Ständers.

Falls der Ständer bereits montiert wurde, entfernen Sie ihn entsprechend des Kapitels 5.4.

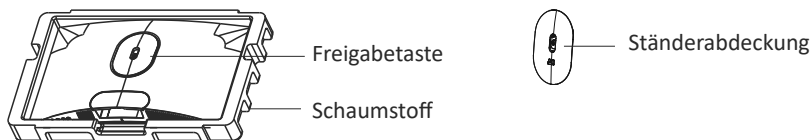

2. Lassen Sie das Schaumstoffteil unter dem Bildschirm, damit er nicht beschädigt wird. Lösen Sie die vier Originalschrauben an der Öffnung an der Rückwand des Monitors (1).

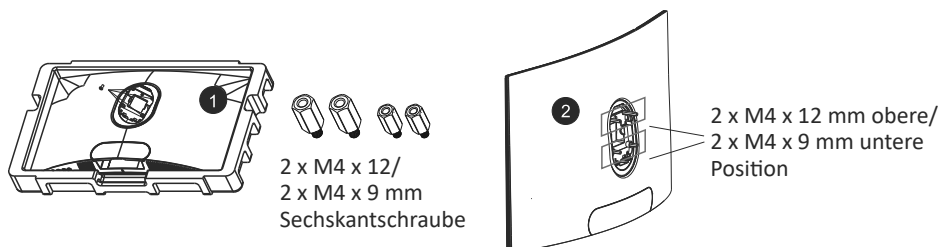

3. Montieren Sie die vier Sechskantschrauben - M4 x 12 mm - an der Oberseite und 2 x M4 x 9 mm an der Unterseite (2).
4. Befolgen Sie die Anweisungen Ihrer Wandhalterung oder eines ähnlichen Zubehörs zur Montage des Monitors.

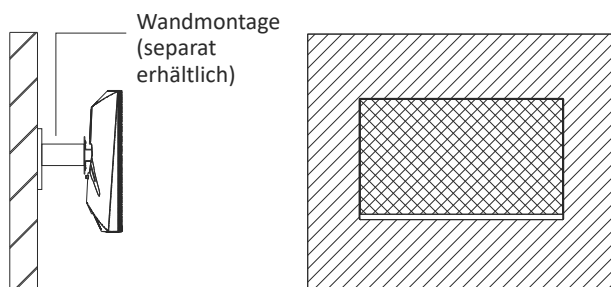

-  Berühren Sie während der Montage nicht den Bildschirm, andernfalls könnte er beschädigt werden. Bewahren Sie die Schrauben auf, falls Sie den Ständer später wieder montieren möchten.

7. Anschließen der Kabel

7.1 Kopfhörer anschließen

Schließen Sie Ihren Kopfhörer an, um Audiosignale von Ihrem Computer zu empfangen.

Wenn Ihr Kopfhörer mit dem Monitor verbunden ist, werden andere Audiogeräte wie Lautsprecher stumm geschaltet. Kopfhörer und andere Audiogeräte sind nicht im Lieferumfang enthalten.

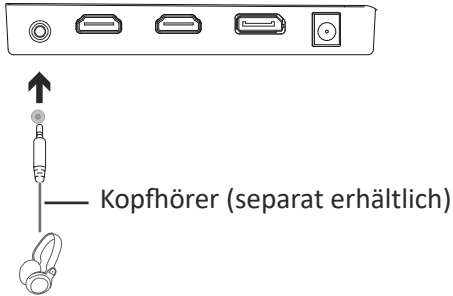

Seien Sie vorsichtig. Wenn Sie über längere Zeit bei hoher Lautstärke hören, kann Ihr Gehör geschädigt werden.

7.2 Netzkabel anschließen

Schließen Sie das Netzkabel am Monitor an. Stecken Sie das Netzkabel danach in eine Steckdose.

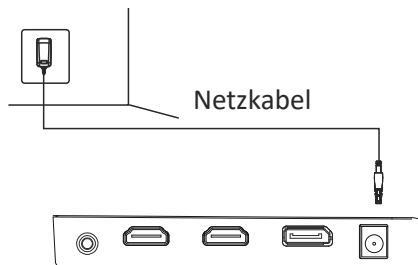

7.3 DP-Verbindung

Verbinden Sie Ihren Monitor und Ihren Computer über das DP-Kabel.

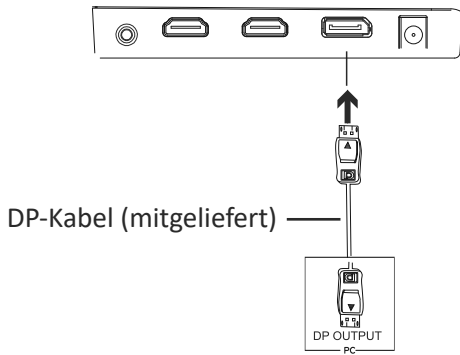

7.4 HDMI-Verbindung

Verbinden Sie Ihren Monitor über das HDMI-Kabel mit Ihrem Computer, falls er nicht über einen DP-Anschluss verfügt.

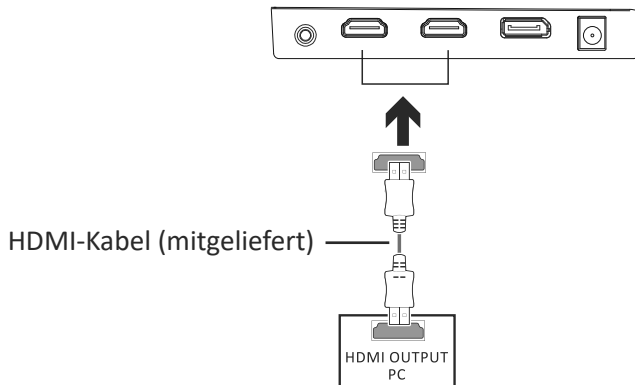

8. Grundbedienung

1. Verbinden Sie Ihren Monitor und die Grafikkarte Ihres Computers über das DP-Kabel.
2. Falls Ihre Grafikkarte kein DP bietet, können Sie stattdessen das HDMI-Kabel nutzen.

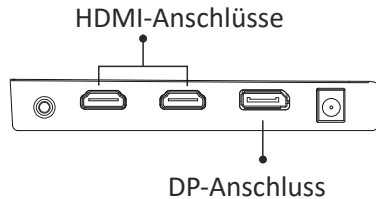

3. Verbinden Sie das Netzkabel mit Ihrem Monitor und einer Steckdose. Sollten Sie eine Steckdose nicht direkt nutzen können und eine Mehrfachsteckdose verwenden, sollte diese einen Überspannungsschutz mit ausreichender Kapazität bieten.
4. Drücken Sie zum Einschalten die Ein-/Aus-Taste des Monitors.

9. Leuchtanzeige

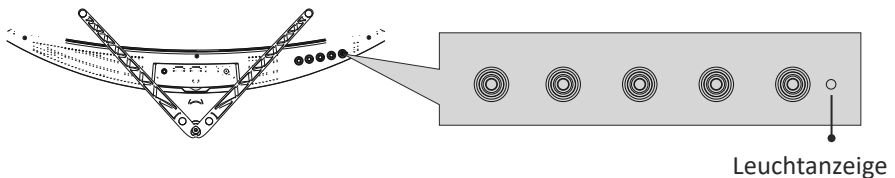

Blaues Leuchten zeigt an, dass der Monitor eingeschaltet ist und normal funktioniert. Blaues Blinken signalisiert, dass keine Videoquelle (kein Horizontal- oder Vertikalsignal) erkannt wurde. Bitte achten Sie darauf, dass Ihr Computer eingeschaltet und das DP- oder HDMI-Kabel richtig angeschlossen ist (vollständig in den Anschluss eingesteckt).

10. OSD-MENÜ

Mit dem OSD-Menü (On-Screen Display) können Sie die Monitoreinstellungen anpassen. Das OSD-Menü erscheint, wenn Sie bei eingeschaltetem Monitor die Menütaste drücken (siehe Kapitel 4.1).

- ☞ Wenn Sie den Monitor zum ersten Mal benutzen, nimmt das Gerät anhand der Konfiguration Ihres Computers automatisch Einstellungen vor. Ändern Sie die Einstellungen entsprechend Ihrer Anforderungen mit dem OSD-Menü und der Grafikkarten-Software.

1. Drücken Sie eine beliebige Taste (**M**, **▼**, **▲**, **E**, **⏻**), zum Aktivieren der Fensternavigation.



2. Drücken Sie die Taste **M** (🏠), um in das OSD-Menü zu gelangen.

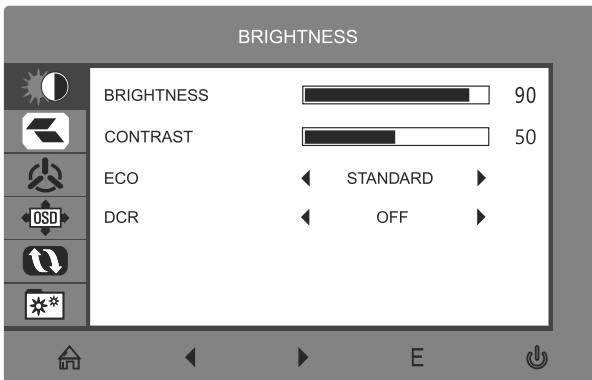

3. Durchsuchen Sie mit **▼** oder **▲** die Funktionen des OSD-Menüs. Markieren Sie die gewünschte Funktion, danach wechseln Sie mit der **M**-Taste in das jeweilige Untermenü. Mit den Tasten **▼** oder **▲** wählen Sie die gewünschte Funktion in den Untermenüs, zur Auswahl drücken Sie die **M**-Taste. Markieren Sie die gewünschte Option mit den Tasten **▼** oder **▲**. Anschließend drücken Sie die **M**-Taste zum Bestätigen der Einstellungen und zum Verlassen des aktuellen Menüs.
4. Drücken Sie die Taste **E**, um den aktuellen Bildschirm und das OSD-Menü zu verlassen.

10.1 OSD-MENÜFUNKTIONEN

Hauptmenü	Untermenü	Optionen	Beschreibung
Helligkeit	Helligkeit	0 – 100	Zum Einstellen der Helligkeit.
	Kontrast	0 – 100	Zum Einstellen des Kontrastes.
	Eco	Standard, Spiel, RTS, FPS, Film, Text	Zum Einstellen des visuellen Modus
	Dyn. Kontrast	Ein	
Aus			Zum Abschalten der DCR-Funktion.
Bild	Seitenverhältnis	Breitbild, Auto, 4:3,	Seitenverhältnis einstellen
	Farbtemperatur	Warm, Benutzer, kühl	Zum Anpassen der Farbtemperatur
	Rot	0~100	Zum Anpassen der RGB-Komponenten
	Grün	0~100	
	Blau	0~100	
OSD-Einstellung	Sprache	English , Español , Русский , Français, 한글 , Português , Deutsch, Türkçe , 简体中文, Polski, Italiano, Nederlands, 日本語	Zur Auswahl der OSD-Sprache.
	OSD H. POS.	0~100	Zum Anpassen der OSD-Horizontalposition.
	OSD V. POS.	0~100	Zum Anpassen der OSD-Vertikalposition.
	OSD-Timer	0~60	Zum Einstellen, wie lange das OSD-Menü im Leerlauf angezeigt wird.
	Transparenz	0~100	Zum Einstellen der OSD-Transparenz.
Zurücksetzen	Autom. Bildanpassung	/	Zum Einstellen der automatischen Anpassung des Anzeigebildes
	Autom. Farbanpassung	/	Zum Einstellen der automatischen Anpassung der Anzeigefarbe
	Reset	/	Zurücksetzen: Zum Zurücksetzen der Monitoreinstellungen
	MPRT	Ein, aus	Reaktionszeit bewegliches Bild
MISC	Signalquelle	DP, HDMI1, HDMI2	Zeigt das Bildsignal an
	Lautstärke	0 ~ 100	Zum Anpassen der Lautstärke.
	Blaulicht reduzieren	0 ~ 100	Zum Einstellen der Blaureduktion.
	AdaptiveSync	Ein, aus	Zum Ein-/Ausschalten von AdaptiveSync
	Übersteuerung	Hoch, mittel, gering, aus	Zum Einstellen der Übersteuerungsfunktion
	LED-Effekt	Normal, Flicker, Aus	LED-Anzeigemodi einstellen

11. Eco-Modi und Gameplus-Umschaltung

1. Drücken Sie eine beliebige Taste (M, ▼, ▲, E, ⏻) zum Aktivieren der Fensternavigation.



2. Drücken Sie die Taste ▼ zum Umschalten zu den Gameplus-Modi. Wählen Sie das Spielsymbol, das am besten zu Ihrem Spiel passt. Diese Spielsymbole sollen in erster Linie das Zielen in Shooter-Spielen optimieren, sie lassen sich aber natürlich auch für andere Zwecke benutzen.



3. Schalten Sie mit ▲ zwischen den LED-Anzeigemodi um oder schalten Sie die LED-Effekte aus.



12. Technische Daten

Modell	LC-M24-FHD-165-C
Bildschirmgröße	23,6"/ 59,94 cm
Bildformat	16:9
Beleuchtung	E-LED
Helligkeit	250 cd/m ² (typisch)
Panel	VA
Auflösung	DP 1.2: 1920 x 1080 bei 165 Hz HDMI 1.4: 1920 x 1080 bei 120 Hz
Bildwiederholfrequenz	165 Hz
Reaktionszeit	OD 4 ms
Betrachtungswinkel	≥ 178° (H) / ≥ 178° (V)
Kontrastverhältnis	3000:1
VESA-Montage	75 x 75 mm
Farben	16,7 Mio.
Adaptive-Sync	Ja
Signaleingang	1 x DP 1.2, 2 x HDMI 1.4
Lautsprecher	Separat erhältlich
Netzkabel, DP-Kabel, HDMI-Kabel, Anleitung	Im Lieferumfang enthalten

TABLE OF CONTENTS

1. Safety precautions
2. Maintenance
3. Box contents
4. Product overview
5. Stand installation
6. Wall mount installation
7. Connectivity options
8. Basic operation
9. Indicator light
10. OSD menu
11. Eco modes and Gameplus switching
12. Technical specifications

1. SAFETY PRECAUTIONS

Do not expose the monitor to a humid environment, rain or other liquids. Do not open the monitor housing to avoid any shock due to electrical or mechanical hazards.

Operation:

- Keep the monitor out of direct sunlight or other heat sources like stoves.
- Keep the monitor away from any liquid.
- Remove any object that could fall into the ventilation holes.
- Do not block the ventilation holes to avoid overheating.
- Do not knock or drop the monitor.

2. MAINTENANCE

CAUTION: Unplug the power cable from the outlet before cleaning the monitor.

- To clean your screen, slightly moisten a soft, clean cloth with water.
- Please use a special screen-cleaning tissue if possible.
- Do not use benzene, thinner, ammonia, abrasive cleaners or compressed air.
- Inappropriate cleaning solutions may damage the monitor or leave a milky film on screen or housing.
- Unplug the monitor if you are not going to use it for a longer time period.
- Do not expose the monitor to dust, liquids or a humid environment.
- In case the monitor gets in touch with any liquid, wipe it down immediately using a dry cloth.
- In case any liquid gets spilled into the ventilation holes, do not use the monitor anymore. Please contact a professional service technician.

Legal notice:



The terms HDMI and HDMI High Definition Multimedia Interface, and the HDMI logo are trademarks or registered trademarks of HDMI Licensing Administrator, Inc. in the USA and other countries.

3. BOX CONTENTS

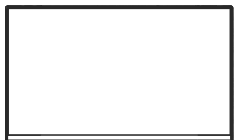

1x monitor

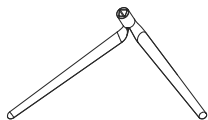

1x stand base

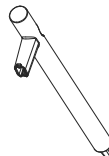

1x stand stem

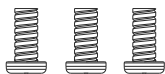

3xPM4x12 screw
(for stand installation)

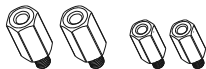

2xM4x12/2xM4x9mm hex bolt
(for wall mounting)



1x stem cover

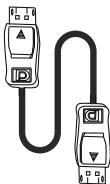

1x DP cable

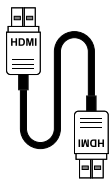

1x HDMI cable

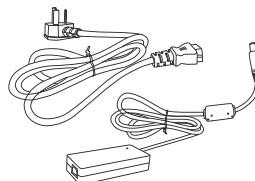

1x Power Cable
1x Power Adapter

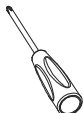

1x screwdriver



1x user manual

 Additional screws may be included as backup.

4. PRODUCT OVERVIEW

4.1 Monitor buttons

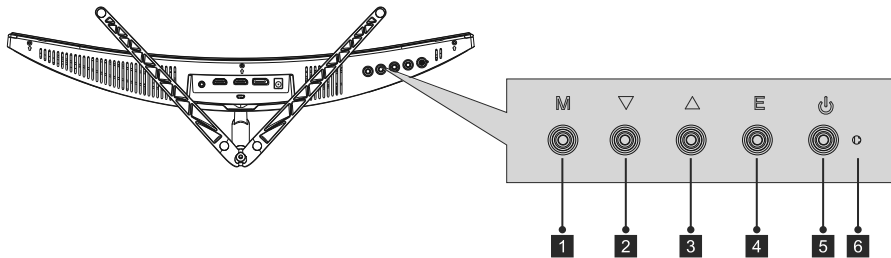

1. Menu button: Press to display the OSD menu or enter submenus.
2. Down button: Press to move down in the menus.
3. Up button: Press to move up in the menus.
4. Exit button: Press to exit the menu.
5. Power button: Press to turn the monitor on and off.
6. LED indicator: Changes colour to indicate the monitor status.

4.2 Monitor ports

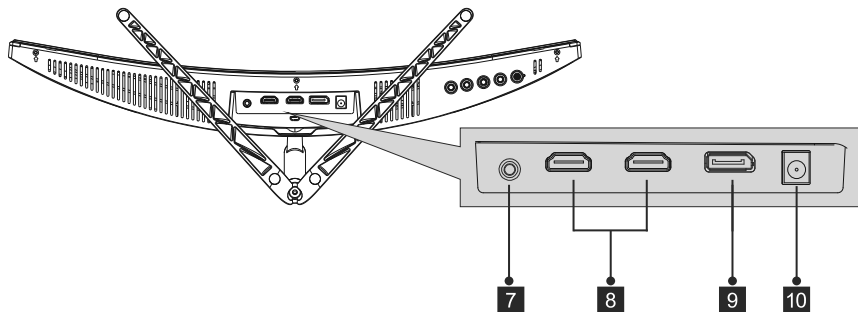

7. Audio output: Connect your headphones or speakers to playback audio signals from the computer.
8. HDMI connectors: Connect a HDMI cable to one of these ports and to the computer's HDMI port (e.g. graphics card or mainboard)
9. DP connector: Connect the DisplayPort cable to this port and to the computer's DisplayPort (e.g. graphics card or mainboard).
10. Power connector: Connect the power cable to the monitor and a wall outlet.

 If you use other DP or HDMI cables, please make sure they support the latest standards to achieve the best picture quality and refresh rate.

5. STAND INSTALLATION

☑ Keep the foam underneath the monitor while attaching the stand.

1. Open the package and take out the product with the foam still attached. Carefully place it on a desk or table and shield the screen.

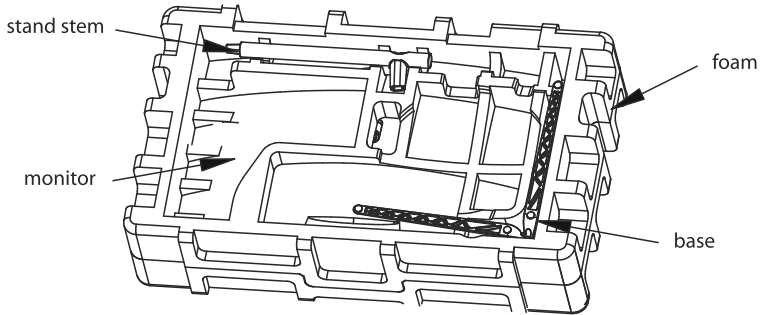

2. Push the base into the stem and mount it with a M4 screw.

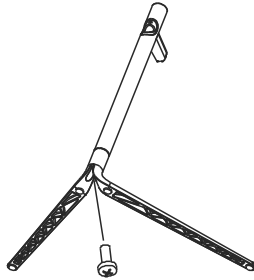

3. Remove the protection from the screen top and place the monitor on a flat surface.

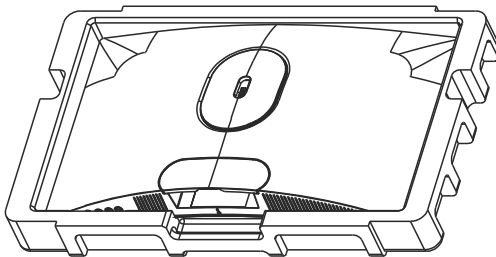

4. Use a M4 screw to attach the stand to the monitor.

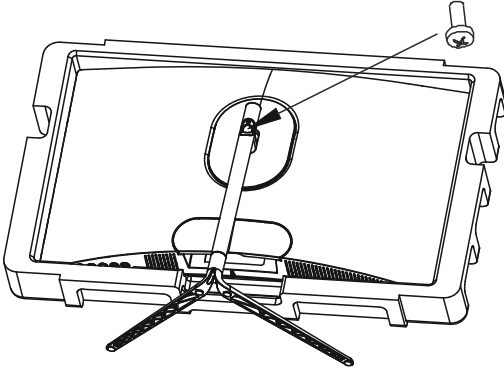

5. Mount the stem cover on the stem to cover the screw.

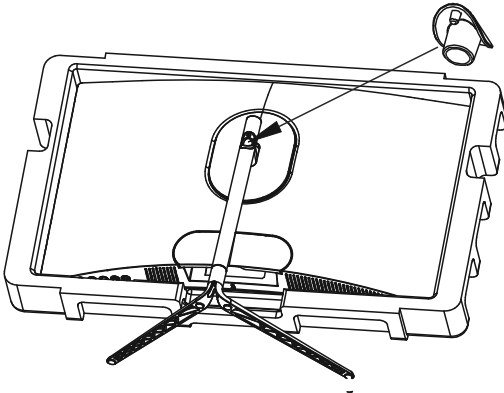

6. You have completed the stand installation.

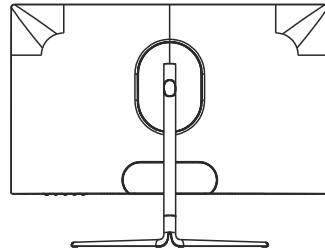
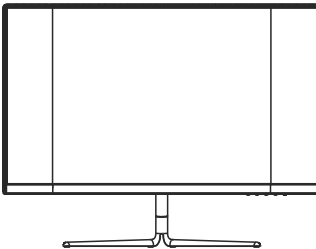

 Keep the foam part attached to the monitor while setting it up.
Do not touch the screen to avoid any damage.

6. WALL MOUNT INSTALLATION

1. Open the package and take out the product with the foam still attached. Carefully place it on a desk or table and shield the screen. Press the release button to remove the stand cover. If the stand has already been mounted, remove it according to chapter 5.4.

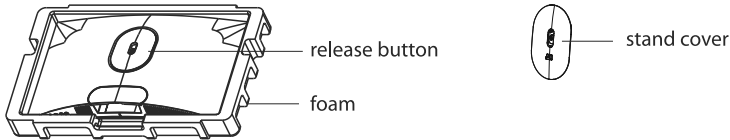

2. Keep the foam underneath the panel to prevent it from breaking. Remove the four original screws from the opening on the back of the monitor (1).

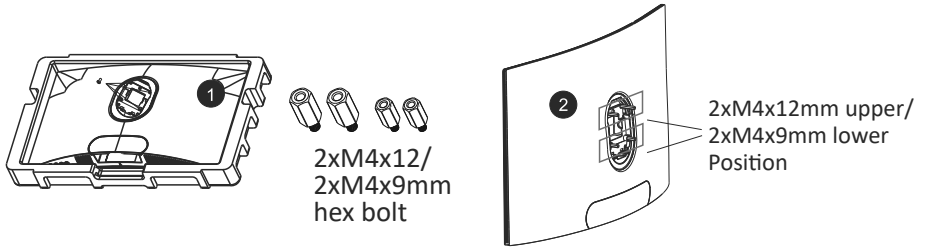

3. Mount the four hex bolts - xM4x12mm on upper and 2xM4x9mm on lower position (2).
4. Follow the instructions of your wall mount or similar accessory to mount the monitor to it.

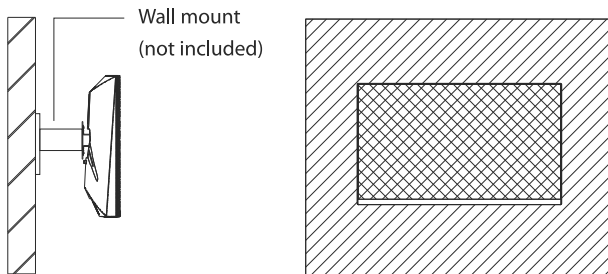

- ⓘ Do not touch the panel during the mounting process to prevent it from breaking. Keep the screws in case you may want to mount the stand later on.

7. CONNECTIVITY OPTIONS

7.1 Connecting your headphones

Plug in your headphones to receive audio signals from your computer. If your headphones are connected to the monitor, other audio devices like speakers will be muted. Headphones or other audio devices are not included in delivery.

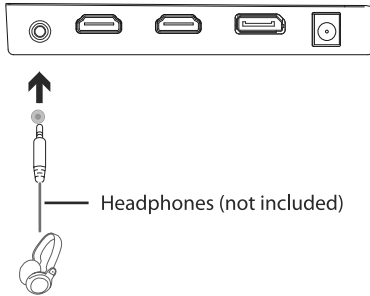

Please be careful, listening to loud audio for a longer time may permanently damage your hearing.

7.2 Connecting the power cable

Connect the power cable to the power connector of the monitor and then to a wall outlet.

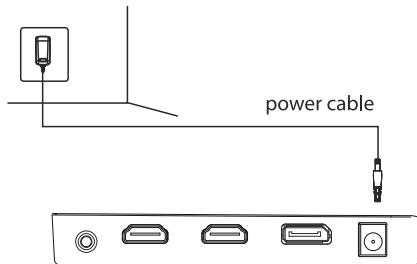

7.3 DP connectivity

Use the DP cable to connect your monitor to your computer.

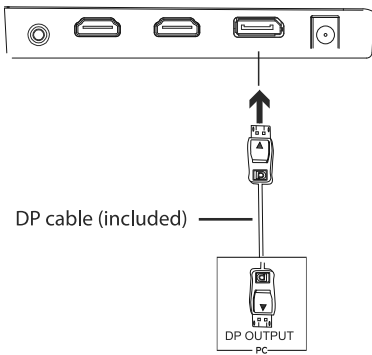

7.4 HDMI connectivity

Use the HDMI cable to connect your monitor to your computer in case it does not offer a DP port.

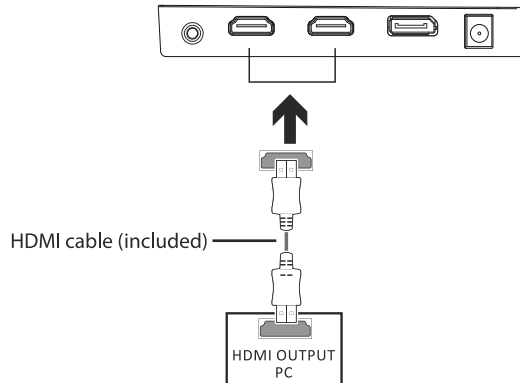

8. BASIC OPERATION

1. Use the DP cable to connect your monitor and your computer's graphics card.
2. If your graphics card doesn't offer DP, you can use the HDMI cable instead.

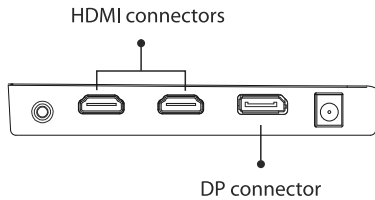

3. Connect the power cable to your monitor and to an outlet. In case you can't reach a wall outlet directly, we recommend to use a surge protector with adequate voltage.
4. Press the power button of the monitor to turn it on.

9. INDICATOR LIGHT

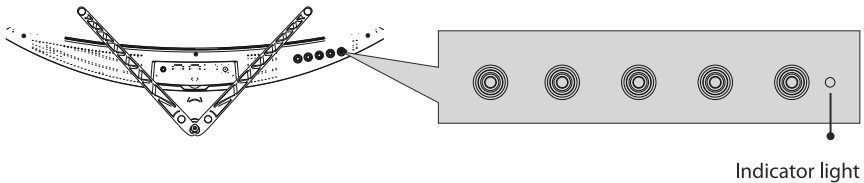

Consistent blue light indicates that the monitor is turned on and operating normally. Flashing blue light indicates that no video source (horizontal or vertical signal) has been detected. Please make sure that your computer is turned on and that the DP or HDMI cable is correctly connected (fully inserted into the port).

10. OSD MENU

The OSD menu (On-Screen Display) may be used to adjust your monitor's settings and appears on screen after turning on the monitor and pressing the menu button (see chapter 4.1).

- ☞ If you use the monitor for the first time, settings will automatically adjust themselves to your computer's configuration. Use the OSD menu and the graphics card software to change settings according to your needs.

1. Press any button to activate the navigation window (**M**, **▼**, **▲**, **E**, **⏻**).



2. Press **M** (**⏻**) to enter the OSD menu.

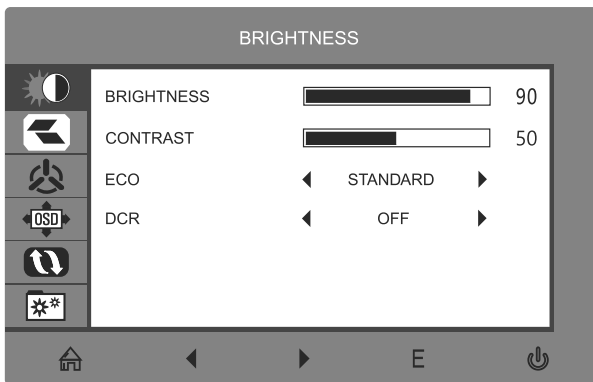

3. Press **▼** or **▲** to browse the functions of the OSD menu.
Highlight the desired function, then press **M** to enter the submenu.
Press **▼** or **▲** to browse submenus, then press **M** to highlight the desired function.
Press **▼** or **▲** to highlight an option, then press **M** to confirm the settings and exit the current screen.
4. Press **E** to exit the current screen and the OSD menu.

10.1 OSD MENU FUNCTIONS

Main Menu	Sub-Menu	Options	Description
BRIGHTNESS	Brightness	0~100	Adjust display brightness
	Contrast	0~100	Adjust display contrast
	ECO	Standard, Game, RTS, FPS, Movie, Text	Set visual mode
	DCR	On	Turn on DCR function
		Off	Turn off DCR function
IMAGE	Aspect	Wide, Auto, 4:3	Set aspect ratio
COLOR TEMP.	Color temp.	Warm, User, Cool,	Adjust color temperature
	Red	0~100	Customize RGB components
	Green	0~100	
	Blue	0~100	
OSD SETTING	Language	English, Español, Русский, Français, 한국, Português, Deutsch, Türkçe, 简体中文, Polski, Italiano, Nederlands ,日语	Set OSD language
	OSD H. POS.	0-100	Adjust the OSD horizontal position
	OSD V. POS.	0-100	Adjust the OSD vertical position
	OSD Timer	0~60	Set how long the OSD remains open after non-use
	Transparency	0-100	Set the OSD overall transparency
RESET	Image auto adjust	N/A	Set auto adjust the display image
	Color auto adjust	N/A	Set auto adjust the display color
	Reset	N/A	Reset monitor configurations
	MPRT	On,Off	Moving Picture Response Time
MISC	Signal source	DP , HDMI1, HDMI2	Display the input signal
	Volume	0-100	Adjust audio volume
	Low blue ray	0-100	Set blue light filtering level
	Adaptive-Syne	On,Off	Turn the Adaptive-Syne On/Off
	Over Driver	High, Middle, Low, Off	Set Overdrive function
	LED Effect	Normal, Flicker, Off	Set led display modes

11. ECO MODES AND GAMEPLUS SWITCHING

1. Press any button to activate the navigation window (M, ▼, ▲, E, ⏻).



2. Press the ▼ button to switch Gameplus modes. Choose the game icon best matching to your game. These game icons are primarily designed to improve your aiming in shooter games, but can of course also be used for other scenarios.



3. Press ▲ to switch LED display modes, or turn off the LED effects.



12. TECHNICAL SPECIFICATIONS

Model	LC-M24-FHD-165-C
Screen size	23,6" / 59,94 cm
Aspect ratio	16:9
Backlight	E-LED
Brightness	250 cd/m ² (typical)
Panel	VA
Resolution	DP 1.2: 1920 x 1080 @ 165Hz HDMI 1.4: 1920 x 1080 @ 120 Hz
Refresh rate	165 Hz
Response time	OD 4 ms
Viewing angle	≥ 178 ° (H) / ≥ 178 ° (V)
Contrast ratio	3000:1
VESA mounting	75 x 75 mm
Colours	16,7 million
Adaptive-Sync	Yes
Signal input	1x DP 1.2, 2x HDMI 1.4
Speakers	Not included
Audio output, power cable, DP cable, Low blue light, flicker-free ,HDMI cable	Included

TABLE DES MATIÈRES

1. Précautions relatives à la sécurité
2. Maintenance
3. Contenu de la boîte
4. Description du produit
5. Installation du socle
6. Montage mural
7. Les options de connectivité
8. Operations de base
9. Témoin lumineux
10. Menu OSD
11. Changement entre les modes ECO et Gameplus
12. Spécifications techniques

1. Précautions relatives à la sécurité

N'exposez pas le moniteur à un environnement humide, à la pluie ou à d'autres liquides. Afin d'éviter tout choc dû à des risques électriques ou mécaniques, n'ouvrez pas le boîtier du moniteur.

Fonctionnement :

- Maintenez le moniteur à l'abri de la lumière directe du soleil ou d'autres sources de chaleur comme les convecteurs.
- Maintenez le moniteur éloigné de tout liquide.
- Retirez tout objet qui pourrait tomber dans les orifices de ventilation.
- Afin d'éviter toute surchauffe, n'obstruez pas les orifices de ventilation.
- Ne heurtez pas et ne laissez pas tomber le moniteur.

2. Maintenance

ATTENTION : Débranchez le cordon d'alimentation de la prise murale avant de nettoyer le moniteur,

- Pour nettoyer votre écran anti-statique, humidifiez légèrement un chiffon doux et propre avec de l'eau.
- Si possible, veuillez utiliser un chiffon spécial de nettoyage d'écran.
- N'utilisez pas de diluant, de benzène, d'ammoniac, de nettoyant abrasif ni d'air comprimé.
- Des solutions de nettoyage inappropriées peuvent endommager le moniteur ou laisser un film laiteux sur l'écran ou le boîtier.
- Débranchez le moniteur si vous ne prévoyez pas de l'utiliser pendant une période prolongée.
- N'exposez pas le moniteur à la poussière, aux liquides ou à un environnement humide.
- Si le moniteur entre en contact avec un liquide, essuyez-le immédiatement avec un chiffon sec.
- En cas de liquide renversé dans les orifices de ventilation, n'utilisez plus le moniteur. Veuillez contacter un technicien de maintenance professionnel.

Rappel légal :

HDMI™
HIGH-DEFINITION MULTIMEDIA INTERFACE

Les termes HDMI, HDMI High-Definition Multimedia Interface et le logo HDMI sont des marques de commerce ou des marques déposées de la HDMI Licensing Administrator, Inc. aux États-Unis et dans d'autres pays.

3. Contenu de la boîte



1 moniteur

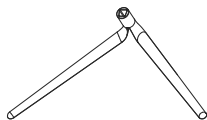

1 socle du support

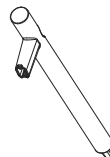

1 pied du support

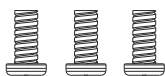

3 vis PM4x12 mm
(pour installation sur support)

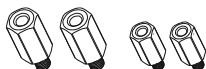

2 boulons hex. M4x12 mm/
2 boulons hex. M4x9 mm
(Pour montage mural)



1 capot de pied

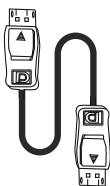

1 câble DP

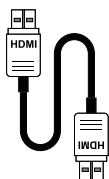

1 câble HDMI

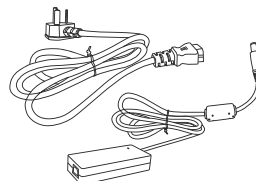

1 câble d'alimentation
1 câble adaptateur

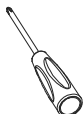

1 tournevis



1 mode d'emploi



Des vis additionnelles peuvent être incluses pour faire office de pièces de rechange.

4. Description du produit

4.1 Boutons du moniteur

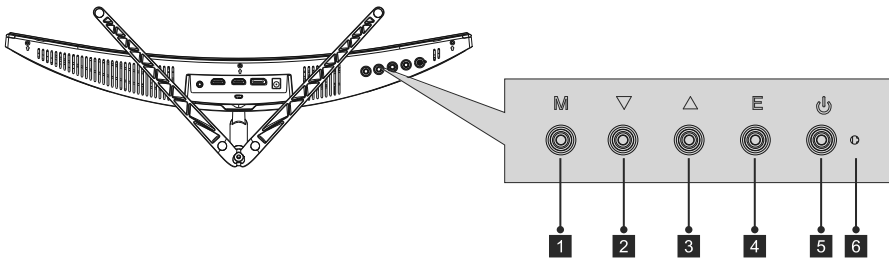

1. Bouton de menu : Appuyer pour afficher le menu OSD ou entrer dans les sous-menus.
2. Bouton bas : Appuyer pour descendre dans les menus.
3. Bouton haut : Appuyer pour monter dans les menus.
4. Bouton quitter : Appuyer pour quitter le menu.
5. Bouton d'alimentation : Appuyer pour allumer/éteindre le moniteur.
6. Voyant DEL : Change de couleur pour indiquer l'état du moniteur.

4.2 Ports du moniteur

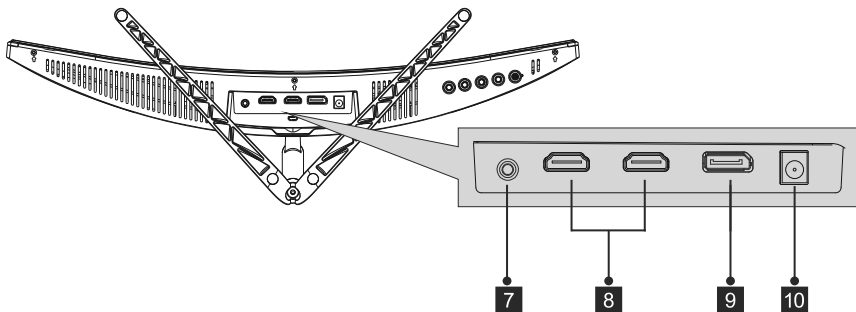

7. Sortie Audio : Branchez votre casque d'écoute ou vos haut-parleurs pour lire les signaux audio de votre ordinateur.
 8. Connecteurs HDMI Reliez le câble HDMI à un de ces ports et au port HDMI de l'ordinateur (par ex. carte graphique ou carte mère)
 9. Connecteur DP Reliez le câble Displayport à ce port et au port Displayport de l'ordinateur (par ex. carte graphique ou carte mère)
 10. Connecteur de courant Reliez le câble adaptateur au moniteur et à une prise de courant murale.
-  Si vous utilisez d'autres câbles DP ou HDMI, assurez-vous qu'ils soient aux normes les plus récentes, ceci afin d'obtenir une qualité d'image et un taux de rafraîchissement optimums.

5. Installation du socle

☑ Conservez la mousse située sous le moniteur lorsque vous le fixez sur le support.

1. Ouvrez l'emballage et sortez le produit avec la mousse. Placez-le précautionneusement sur un bureau ou une table et protégez l'écran.

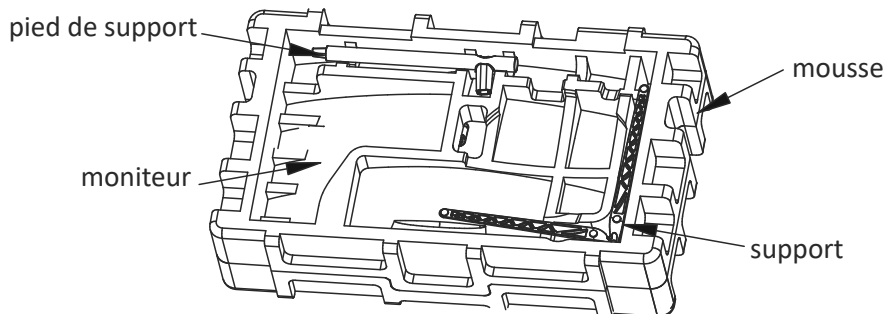

2. Enfoncez le socle dans le pied et fixez-les à l'aide d'une vis M4.

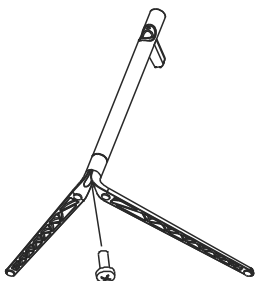

3. Retirez la protection du dessus l'écran et disposez le moniteur sur une surface plate.

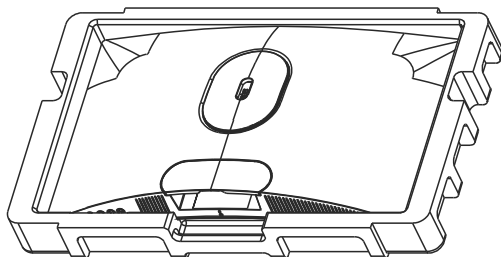

4. Fixez le support au moniteur à l'aide d'une vis M4.

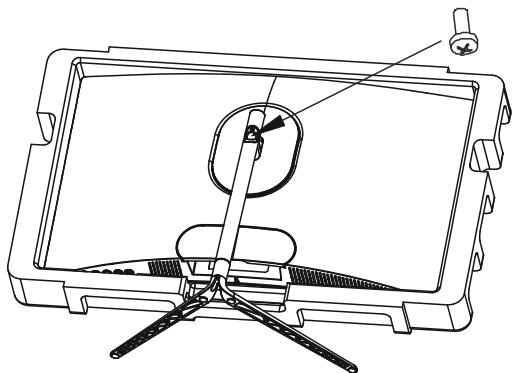

5. Montez le capot du pied sur le pied pour recouvrir les vis.

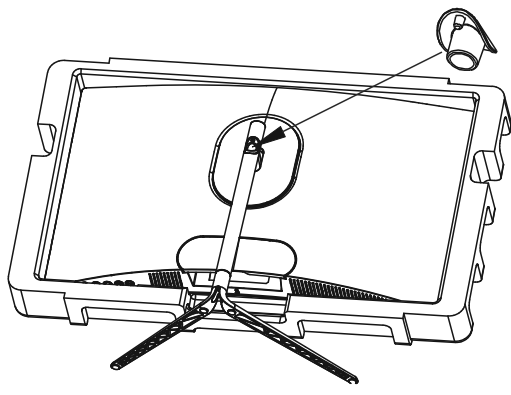

6. L'installation du socle est terminée.

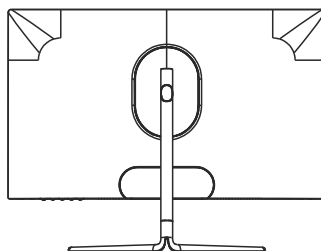
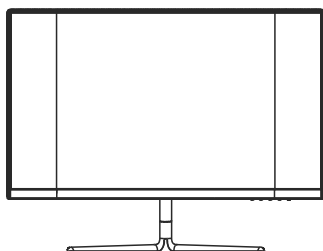

-  Gardez la partie en mousse attachée au moniteur lors de l'installation. Ne touchez pas l'écran pour éviter de l'endommager.

6. Montage mural

1. Ouvrez l'emballage et sortez le produit avec la mousse. Placez-le précautionneusement sur un bureau ou une table et protégez l'écran. Appuyez sur le bouton d'ouverture rapide pour retirer le capot du support. Si le support est déjà monté, retirez-le conformément aux instructions données dans le point 5.4.

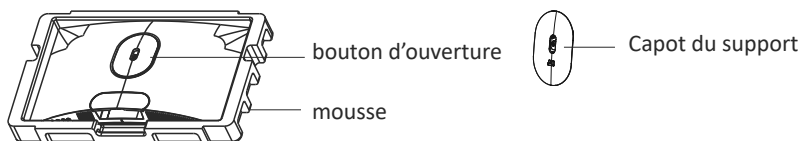

2. Gardez la mousse sous le panneau pour l'empêcher de casser. Retirez les quatre vis originales attachées sur l'ouverture située au dos du moniteur (1).

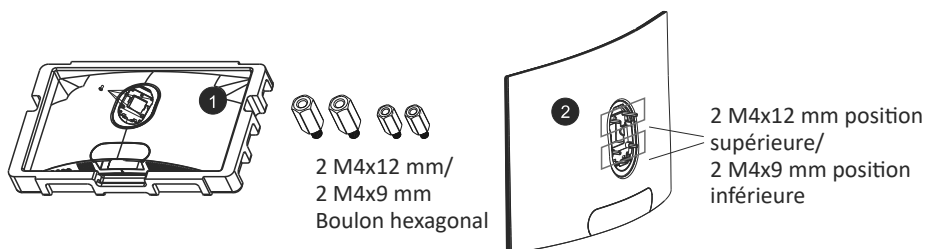

3. Installez les quatre boulons hexagonaux x - 2 M4x12 mm dans la position supérieure et 2 M4x9 mm dans la position inférieure (2).
4. Suivez les instructions de votre support mural ou autre accessoire similaire pour y installer dessus le moniteur.

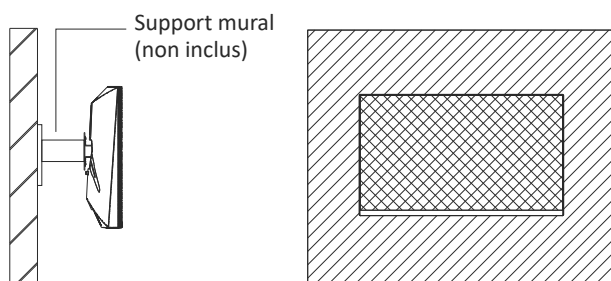

-  Ne touchez pas le panneau pendant le montage afin d'éviter qu'il ne casse. Conservez les vis dans la boîte dans le cas où vous souhaiteriez installer le support ultérieurement.

7. Les options de connectivité

7.1 Connexion de vos écouteurs

Branchez vos écouteurs pour recevoir les signaux audio de votre ordinateur. Si vos écouteurs sont connectés au moniteur, les autres dispositifs audio comme les haut-parleurs passeront en mode silencieux. Les écouteurs ou autres dispositifs audio ne sont pas inclus dans la livraison.

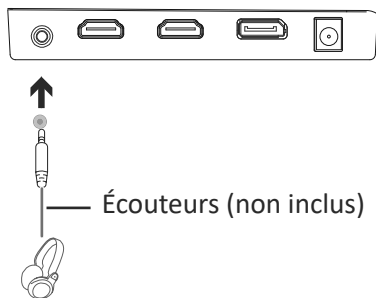

Soyez prudent, écouter à un volume élevé pendant une durée prolongée peut endommager l'ouïe.

7.2 Branchement du câble d'alimentation

Soyez prudent, écouter à un volume élevé pendant une durée prolongée peut endommager l'ouïe.

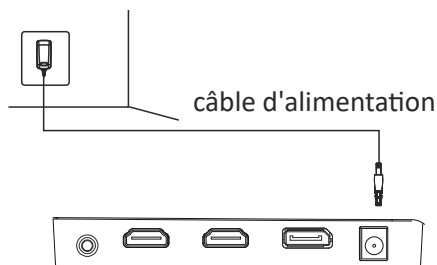

7.3 Connectivité DP

Utilisez le câble DP pour relier votre moniteur à votre ordinateur.

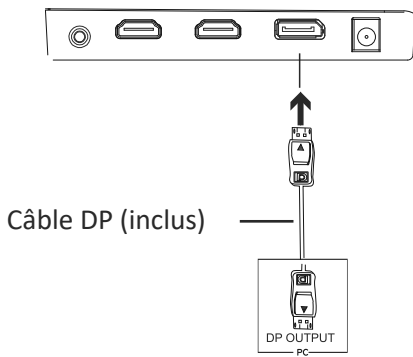

7.4 Connectivité HDMI

Utilisez le câble HDMI pour relier votre moniteur à votre ordinateur s'il ne comporte pas de port DP.

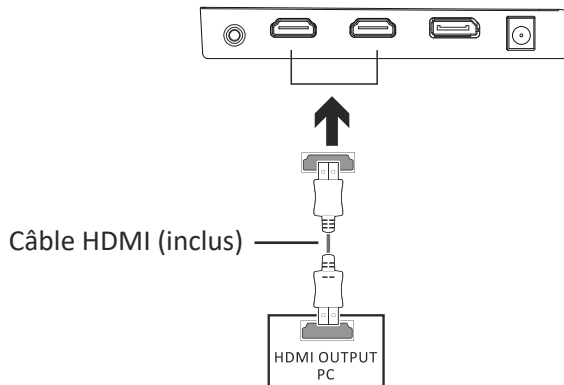

8. Opérations de base

1. Utilisez le câble DP pour relier votre moniteur à la carte graphique de votre ordinateur.
2. Si votre carte graphique n'est pas dotée de DP, vous pouvez utiliser à la place un câble HDMI.

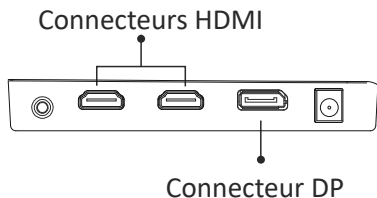

3. Reliez le câble d'alimentation à votre moniteur et à une prise de courant. Si vous ne pouvez pas atteindre directement la prise, nous vous conseillons d'utiliser un parasurtenseur de la tension appropriée.
4. Appuyez sur le bouton d'alimentation du moniteur pour l'allumer.

9. Témoin lumineux

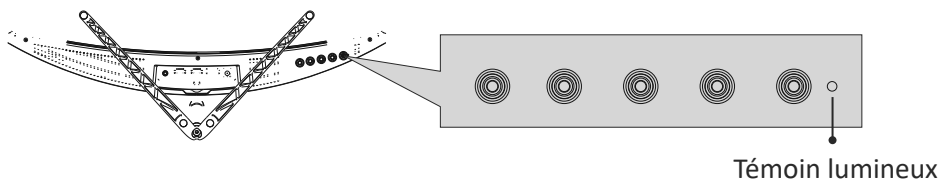

Un voyant bleu constant indique que le moniteur est allumé et fonctionne normalement. Le voyant bleu clignotant indique qu'aucune source vidéo, (signal horizontal ou vertical) n'a été détectée. Assurez-vous que votre ordinateur est allumé et que le câble DP ou HDMI est correctement branché (entièrement inséré dans le port).

10. MENU OSD

Le menu d'affichage à l'écran (OSD) peut servir à ajuster les paramètres de votre moniteur, il apparaîtra à l'écran après que vous avez allumé le moniteur et appuyé sur le bouton de menu (cf. Section 4.1).

- ☞ Si vous utilisez le moniteur pour la première fois, les paramètres s'ajusteront automatiquement pour la configuration de votre ordinateur. Utilisez le menu OSD et le logiciel de la carte graphique pour modifier les paramètres en fonction de vos besoins.

1. Appuyez sur n'importe quel bouton (**M**, **▼**, **▲**, **E**, **⏻**) pour activer la fenêtre de navigation.



2. Appuyez sur **M** (🏠) pour entrer dans le menu OSD.

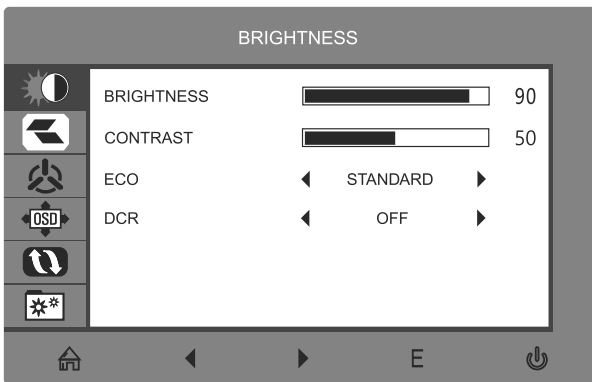

3. Appuyez sur **▼** ou **▲** pour parcourir les fonctions du menu OSD. Mettez en surbrillance la fonction désirée puis appuyez sur **M** pour entrer dans le sous-menu. Appuyez sur **▼** ou **▲** pour naviguer dans les sous-menus, puis appuyez sur **M** pour mettre en surbrillance la fonction désirée. Appuyez sur **▼** ou **▲** pour mettre en surbrillance une option, puis appuyez sur **M** pour confirmer le paramètre et quitter l'écran courant.
4. Appuyez sur **E** pour quitter l'écran courant et le menu OSD

10.1 Fonctions du menu OSD

Menu principal	Sous-menu	Options	Description
Luminosité	Luminosité	0-100	Régler la luminosité de l'écran
	Contraste	0-100	Régler le contraste de l'écran
	ECO	Standard, Jeu, RTS, FPS, Film, Texte	Régler le mode visuel
	DCR	Activé	Activer la fonction DCR
Désactivé		Désactiver la fonction DCR	
IMAGE	Aspect	Large, Auto, 4:3	Réglez le format d'image
	Température de couleur	Chaud, Utilisateur, Froid	Ajuster la température de couleur
	Rouge	0~100	Personnaliser les composants RVB
	Vert(e)	0~100	
	Bleu(e)	0~100	
RÉGLAGE OSD	Langue	English , Español , Русский , Français, 한글 , Portuguais , Deutsch, Türkçe , 简体中文, Polski, Italiano, Nederlands, 日本語	Régler la langue de l'OSD
	OSD H.POS.	0~100	Ajuster la position horizontale de l'OSD
	POS. OSD V.	0~100	Régler la position verticale de l'OSD
	Minuteur OSD	0~60	Configurez la durée pendant laquelle l'OSD reste activé sans être utilisé.
	Transparence	0~100	Régler la transparence globale de OSD
Réinitialiser	Autoréglage de l'image	S/O	Configurez le réglage automatique de l'image affichée à l'écran
	Autoréglage des couleurs	S/O	Configurez le réglage automatique des couleurs de l'écran
	Réinitialiser	S/O	Réinitialiser les configuration du moniteur
	MPRT	Marche, Arrêt	Temps de réponse d'image mobile
DIVERS	Source du signal	DP, HDMI1, HDMI2	Affichage du signal d'entrée
	Volume	0-100	Régler le volume audio
	Faible lumière bleue	0-100	Régler le niveau de filtrage de la lumière bleue
	Adaptive-Syne	Marche, Arrêt	Activer/ Désactiver la fonction de Adaptive-Syne
	Over Driver	Haut, Moyen, Bas, Arrêt	Confirmez la fonction Overdrive
	Effets DEL	Normal, clignotant, éteint	Configurer les modes d'affichage LED

11. Changement entre les modes ECO et Gameplus

1. Appuyez sur n'importe quel bouton (M, ▼, ▲, E, ⏻) pour activer la fenêtre de navigation.



2. Appuyez sur le bouton ▼ pour changer de mode Gameplus. Choisissez l'icône de jeu qui correspond le mieux à votre jeu. Ces icônes de jeu sont à la base conçues pour améliorer votre visée dans les jeux de tir, mais elles peuvent aussi être utilisées dans d'autres scénarios.



3. Appuyez sur ▲ pour changer entre les modes d'affichage arrière LED ou pour éteindre les effets LED.



12. Spécifications techniques

Modèle	LC-M24-FHD-165-C
Taille d'écran	23,6" / 59,94 cm
Format d'image	16:9
Rétroéclairage	E-LED
Luminosité	250 cd/m ² (typique)
Panneau	VA
Résolution	DP 1.2:1920x1080 @ 165 Hz HDMI 1.4:1920 x 1080 @ 120 Hz
Taux de rafraîchissement	165 Hz
Temps de réponse	OD4 ms
Angles de vue	≥178° (H)/≥178° (V)
Taux de contraste	3000:1
Montage VESA	75x75 mm
Couleurs	16,7 million
Adaptive-Sync	Oui
Entrée de signal	1 x DP1.2, 2 x HDMI1.4
Haut-parleurs	Non inclus
Câble d'alimentation de sortie audio, câble DP, câble HDMI, lumière bleue faible, sans clignotement	Inclus

INDICE

1. Precauzioni sulla sicurezza
2. Manutenzione
3. Contenuto della confezione
4. Descrizione del prodotto
5. Installazione del supporto
6. Montaggio a parete
7. Opzioni di connettività
8. Funzionamento di base
9. Indicatore
10. Menu OSD
11. Commutazione modalità Eco e Gameplus
12. Specifiche tecniche

1. Precauzioni sulla sicurezza

Non esporre il monitor a un ambiente umido, pioggia o altri liquidi.
Non aprire l'alloggiamento del monitor per evitare scosse dovute a rischi elettrici o meccanici.

Funzionamento:

- Tenere il monitor lontano dalla luce solare diretta o da altre fonti di calore come stufe.
- Tenere il monitor lontano da qualsiasi liquido.
- Rimuovere eventuali oggetti che potrebbero cadere nei fori di ventilazione.
- Non ostruire i fori di ventilazione per evitare il surriscaldamento.
- Non far subir urti né far cadere il monitor.

2. Manutenzione

ATTENZIONE: Scollegare il cavo di alimentazione dalla presa prima di pulire il monitor.

- Per pulire lo schermo, inumidire leggermente un panno morbido e pulito.
- Utilizzare uno speciale panno per la pulizia dello schermo, se possibile.
- Non utilizzare benzene, solventi, ammoniaca, detersivi abrasivi o aria compressa.
- Le soluzioni di pulizia inadeguate potrebbero danneggiare il monitor o lasciare una pellicola lattiginosa sullo schermo o sull'alloggiamento.
- Scollegare il monitor se non lo si utilizza per un periodo di tempo più lungo.
- Non esporre il monitor a polvere, liquidi o ambienti umidi.
- Se il monitor viene a contatto con qualsiasi liquido, pulirlo immediatamente con un panno asciutto.
- In caso di versamento di liquido nei fori di ventilazione, non utilizzare più il monitor. Contattare un tecnico di assistenza professionale.

Avviso legale:



I termini HDMI, High-Definition Multimedia Interface e il logo HDMI sono marchi di fabbrica o marchi registrati di HDMI Licensing Administrator, Inc. negli Stati Uniti e in altri Paesi.

3. Contenuto della confezione

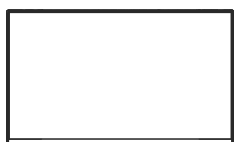

1 x monitor

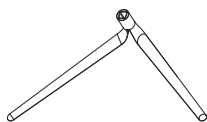

1 x base del supporto

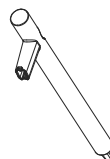

1 x attacco supporto

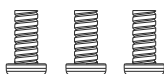

3xPM4x12 vite
(per installazione del supporto)



2xM4x12/2xM4x9mm
bulloni esagonali
(Per montaggio a parete)



1 x coperchio attacco

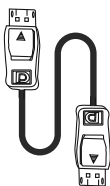

1 x cavo DP

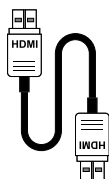

1 x cavo HDMI

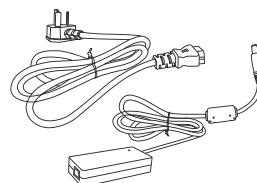

1 x cavo di alimentazione
1 x adattatore di alimentazione

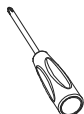

1 x cacciavite



1 x manuale utente

 Potrebbero essere incluse viti extra di ricambio.

4. Descrizione del prodotto

4.1 Tasti del monitor

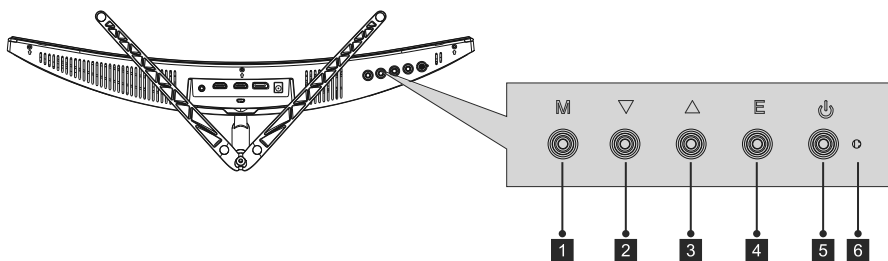

1. Tasto Menu: Premere per visualizzare il menu OSD o accedere ai menu secondari.
2. Tasto giù: premere per spostarsi verso il basso nei menu.
3. Tasto su: premere per spostarsi verso l'alto nei menu.
4. Tasto Esci: premere per uscire dal menu.
5. Tasto di alimentazione: premere per accendere e spegnere il monitor.
6. Indicatore LED: cambia colore per indicare lo stato del monitor.

4.2 Porte del monitor

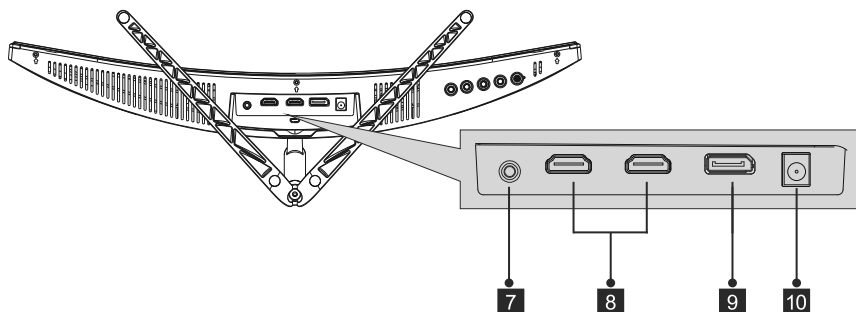

7. Uscita audio: Collegare le cuffie o gli altoparlanti per riprodurre i segnali audio dal computer.
8. Connettori HDMI: Collegare il cavo HDMI a una di queste porte e alla porta HDMI del computer (ad esempio, scheda grafica o scheda madre).
9. Connettore DP: Collegare il cavo DisplayPort a questa porta e alla porta DisplayPort del computer (ad esempio, scheda grafica o scheda madre).
10. Connettore di alimentazione: Collegare il cavo di alimentazione al monitor e alla presa di corrente.

-  Se si utilizzano altri cavi DP o HDMI, assicurarsi che supportino gli standard più recenti per ottenere la migliore qualità dell'immagine e la frequenza di aggiornamento.

5. Installazione del supporto

 Tenere il polistirolo sotto il monitor mentre si fissa il supporto.

1. Aprire la confezione ed estrarre il prodotto con la gommapiuma ancora inserito. Posizionarlo con cura su una scrivania o un tavolo e riparare lo schermo.

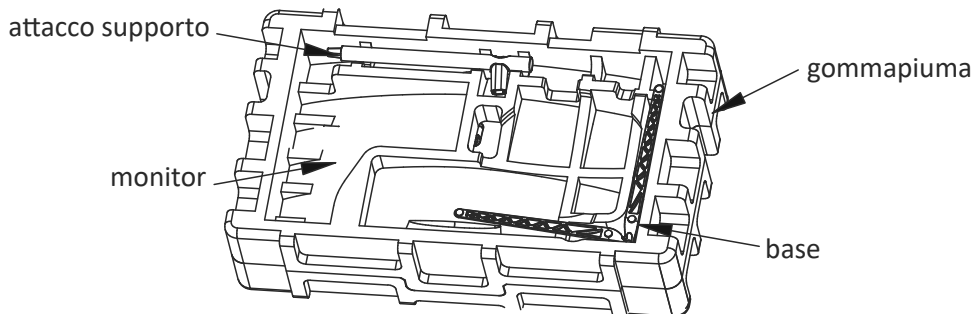

2. Spingere la base nell'attacco e montarla con una vite M4.

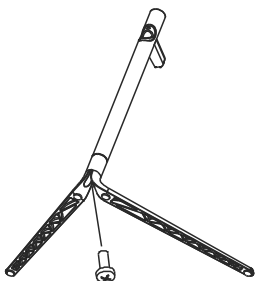

3. Rimuovere la protezione dalla parte superiore dello schermo e collocare il monitor su una superficie piana.

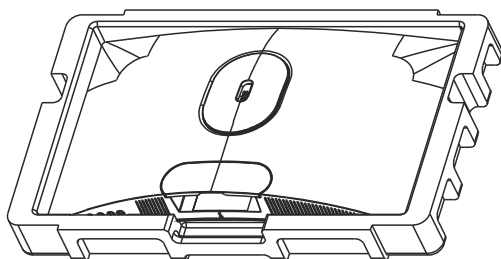

4. Utilizzare una vite M4 per fissare il supporto al monitor.

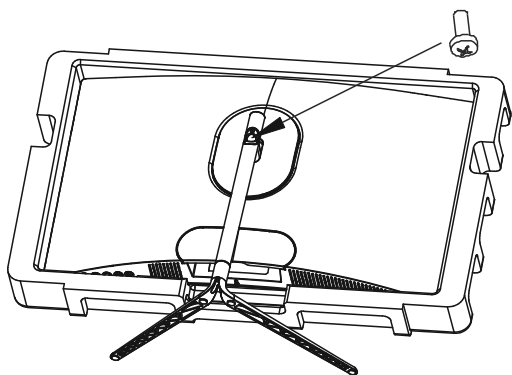

5. Montare il coperchio dell'attacco sull'attacco stesso per coprire la vite.

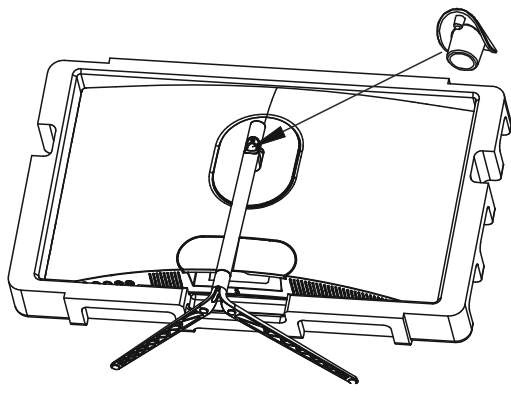

6. Si è completata l'installazione del supporto.

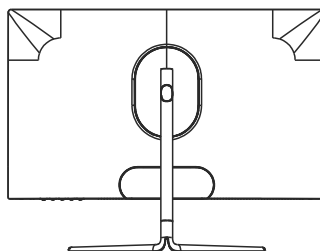
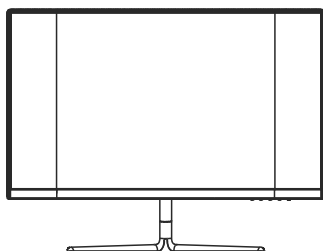

-  Tenere la parte in polistirolo fissata al monitor durante l'installazione.
Non toccare lo schermo per evitare danni.

6. Montaggio a parete

1. Aprire la confezione ed estrarre il prodotto con la gommapiuma ancora inserito. Posizionarlo con cura su una scrivania o un tavolo e riparare lo schermo.

Premere tasto di sgancio per rimuovere il coperchio del supporto.

Se il supporto è già stato montato, rimuoverlo secondo il capitolo 5.4.

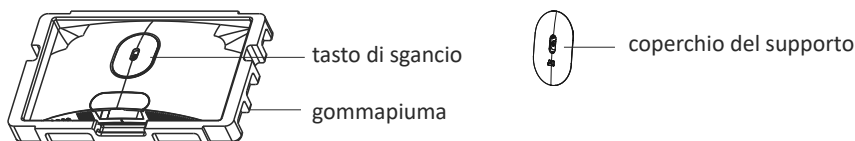

2. Tenere il polistirolo sotto il pannello per evitare che si rompa. Rimuovere le quattro viti originali fissate all'apertura sul retro del monitor (1).

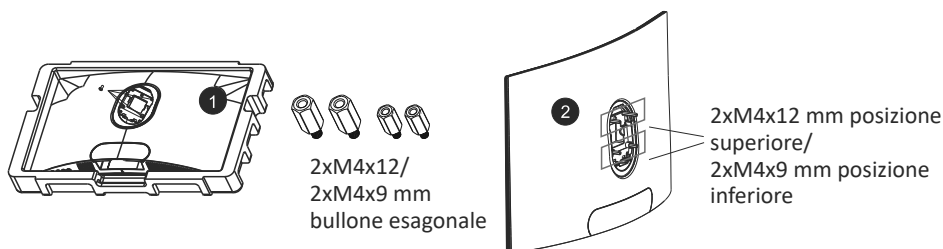

3. Montare i quattro bulloni esagonali - xM4x12 mm sulla posizione superiore 2xM4x9 mm sulla posizione inferiore (2).
4. Seguire le istruzioni del supporto a parete o di un accessorio simile per montare il monitor su di esso.

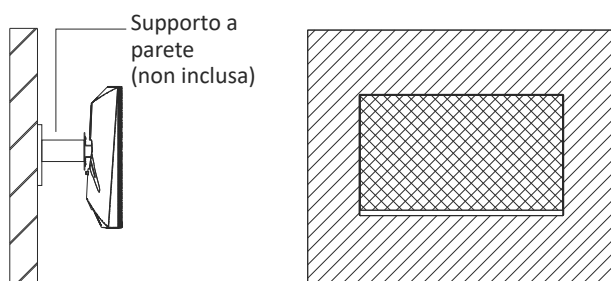

- ⓘ Non toccare il pannello durante il processo di montaggio per evitare che si rompa. Conservare le viti nel caso si desideri montare il supporto in seguito.

7. Opzioni di connettività

7.1 Collegamento delle cuffie

Collegare le cuffie per ricevere segnali audio dal computer.

Se le cuffie sono collegate al monitor, altri dispositivi audio come gli altoparlanti verranno disattivati. Le cuffie o altri dispositivi audio non sono forniti in dotazione.

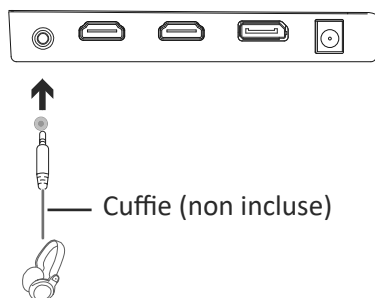

Prestare attenzione: l'ascolto di audio ad alto volume per un periodo prolungato potrebbe danneggiare in modo permanente l'udito.

7.2 Collegamento del cavo di alimentazione

Prestare attenzione: l'ascolto di audio ad alto volume per un periodo prolungato potrebbe danneggiare in modo permanente l'udito.

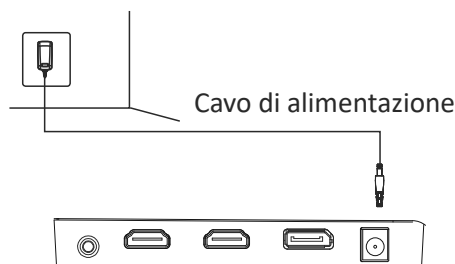

7.3 Connettività DP

Utilizzare il cavo DP per collegare il monitor al computer.

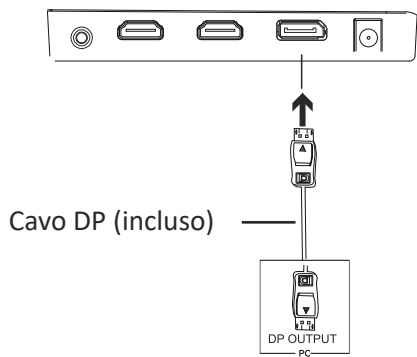

7.4 Connettività HDMI

Utilizzare il cavo HDMI per collegare il monitor al computer nel caso in cui non sia disponibile una porta DP.

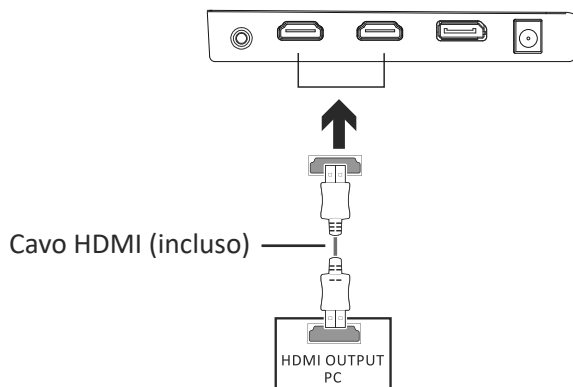

8. Funzionamento di base

1. Utilizzare il cavo DP per collegare il monitor e la scheda grafica del computer.
2. Se la scheda grafica non dispone di DP, è possibile utilizzare il cavo HDMI.

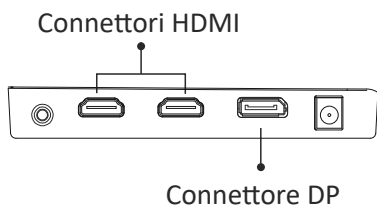

3. Collegare il cavo di alimentazione al monitor e ad una presa di rete. Nel caso in cui non sia possibile raggiungere direttamente una presa a parete, si consiglia di utilizzare un dispositivo di protezione da sovratensioni con tensione adeguata.
4. Premere il tasto di alimentazione del monitor per accenderlo.

9. INDICATORE

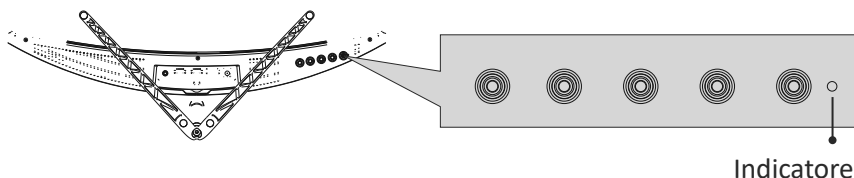

La spia blu fissa indica che il monitor è acceso e funziona normalmente. La spia blu lampeggiante indica che non è stata rilevata alcuna sorgente video (segnale orizzontale o verticale). Assicurarsi che il computer sia acceso e che il cavo DP o HDMI sia collegato correttamente (completamente inserito nella porta).

10. MENU OSD

Il menu OSD (On-Screen Display) può essere utilizzato per regolare le impostazioni del monitor e appare sullo schermo dopo aver acceso il monitor e premuto il tasto Menu (vedere il capitolo 4.1).

☒ Se si utilizza il monitor per la prima volta, le impostazioni si adattano automaticamente alla configurazione del computer. Utilizzare il menu OSD e il software della scheda grafica per modificare le impostazioni in base alle proprie esigenze.

1. Premere un tasto (**M**, **▼**, **▲**, **E**, **⏻**) per attivare la finestra di navigazione



2. Premere **M** (**🏠**) per accedere al menu OSD.

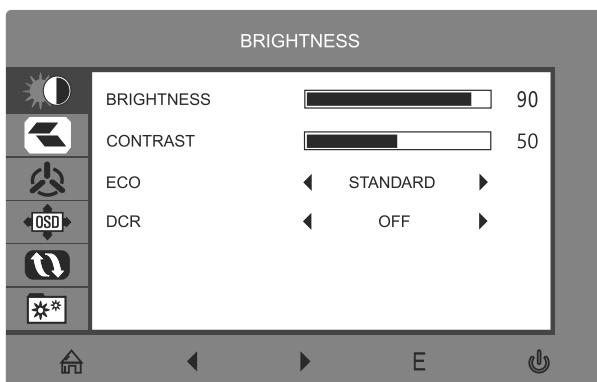

3. Premere **▼** o **▲** per passare tra le funzioni del menu OSD. Evidenziare la funzione desiderata, quindi premere **M** per accedere al sottomenu. Premere **▼** o **▲** per passare tra i menu secondari, quindi premere **M** per evidenziare la funzione desiderata. Premere **▼** o **▲** per evidenziare un'opzione, quindi premere **M** per confermare le impostazioni e uscire dalla schermata attuale.
4. Premere **E** per uscire dalla schermata attuale e dal menu OSD.

10.1 FUNZIONI DEL MENU OSD

Menu principale	Menu secondario	Opzioni	Descrizione
LUMINOSITÀ	Luminosità	0-100	Regola la luminosità del display
	Contrasto	0-100	Regola il contrasto del display
	ECO	Standard, Gioco, RTS, FPS, Film, Testo	Imposta modalità visiva
	DCR	Attiva	Attiva la funzione DCR
		Disattiva	Disattiva la funzione DCR
IMMAGINE	Proporzioni	Wide, Auto, 4:3	Imposta le proporzioni
	Temp. colore	Caldo, Utente, Freddo,	Regola la temperatura colore
	Rosso	0~100	Personalizza componenti RGB
	Verde	0~100	
	Blu	0~100	
IMPOSTAZIONE OSD	Lingua	English , Español , Русский, Français, 한글 , Português , Deutsch, Türkçe , 简体中文, Polski, Italiano, Nederlands, 日本語	Imposta la lingua OSD
	POS. O. OSD	0~100	Regola la posizione orizzontale dell'OSD
	POS. V. OSD	0~100	Regola la posizione verticale dell'OSD
	Timer OSD	0~60	Imposta per quanto tempo l'OSD rimane aperto dopo il mancato utilizzo
	Trasparenza	0~100	Imposta la trasparenza generale dell'OSD
Ripristina	Regolazione automatica immagine	N/A	Imposta la regolazione automatica dell'immagine del display
	Regolazione automatica colore	N/A	Imposta la regolazione automatica del colore del display
	Ripristina	N/A	Ripristina le configurazioni del monitor
	MPRT	On, Off	Tempo di risposta immagine in movimento
MISC (Varie)	Origine segnale	DP, HDMI1, HDMI2	Visualizza il segnale di ingresso
	Volume	0-100	Regola il volume audio
	Raggi blu bassi	0-100	Imposta il livello di filtraggio della luce blu
	Adaptive-Sync	On, Off	Attiva/disattiva la funzione Adaptive-Sync
	OVERDRIVE	Alto, Medio, Basso, Off	Imposta la funzione Overdrive
	Effetto LED	Normale, Sfarfallio, Disattiva	Imposta le modalità di visualizzazione LED

11. Commutazione modalità eco e gameplus

1. Premere un tasto (M, ▼, ▲, E, ⏻) per attivare la finestra di navigazione.



2. Premere il tasto ▼ per passare alle modalità Gameplus. Scegliere l'icona di gioco che si adatta meglio al gioco. Queste icone di gioco sono progettate principalmente per migliorare la mira nei giochi FPS, ma possono ovviamente essere utilizzate anche per altri scenari.



3. Premere ▲ per commutare le modalità display posteriore a LED o spegnere gli effetti LED.



12. Specifiche tecniche

Modello	LC-M24-FHD-165-C
Dimensioni schermo	23,6"/ 59,94 cm
Proporzioni	16:9
Retroilluminazione	E-LED
Luminosità	250 cd/m ² (tipico)
Pannello	VA
Risoluzione	DP 1.2:1920x1080 a 165 Hz HDMI 1.4:1920 x 1080 a 120 Hz
Frequenza di aggiornamento	165 Hz
Tempo di risposta	OD4 ms
Angolo di visione	≥178° (0)/≥178° (V)
Rapporto di contrasto	3000:1
Supporto VESA	75x75mm
Colori	16,7 milioni di pressioni
Adaptive-Sync	Sì
Ingresso segnale	1 x DP1.2, 2 x HDMI1.4
Altoparlanti	Non incluso
Cavo di alimentazione uscita audio, cavo DP,cavo HDMI, luce blu bassa, antisfarfallio	Incluso

TABLA DE CONTENIDO

1. Precauciones de seguridad
2. Mantenimiento
3. Contenido de la caja
4. Información general del producto
5. Instalación del pedestal
6. Instalación en pared
7. Opciones de conectividad
8. Funcionamiento básico
9. Indicador luminoso
10. Menú OSD
11. Cambio a los modos ECO y Gameplus
12. Especificaciones técnicas

1. PRECAUCIONES DE SEGURIDAD

No exponga el monitor a un entorno húmedo, a la lluvia ni a otros líquidos. Para evitar descargas eléctricas debidas a riesgos eléctricos o mecánicos, no abra la carcasa del monitor.

Funcionamiento:

- Mantenga el monitor alejado de la luz solar directa u otras fuentes de calor como puede ser una estufa.
- Mantenga el monitor alejado de cualquier líquido.
- Retire cualquier objeto que pueda caer en los orificios de ventilación.
- Para evitar el sobrecalentamiento, no bloquee los orificios de ventilación.
- No golpee ni deje caer el monitor.

2. MANTENIMIENTO

PRECAUCIÓN: Desenchufe el cable de alimentación de la toma de corriente antes de limpiar el monitor.

- Para limpiar la pantalla, humedezca ligeramente un paño suave y limpio con agua.
- Si es posible, utilice una toallita especial para limpiar pantallas.
- No utilice benceno, diluyentes, amoníaco, limpiadores abrasivos o aire comprimido.
- Las soluciones de limpieza inadecuadas pueden dañar el monitor o dejar una película lechosa en la pantalla o la carcasa.
- Desenchufe el monitor si no la va a utilizar durante un prolongado período de tiempo.
- No exponga el monitor al polvo, a líquidos o a un entorno húmedo.
- En caso de que el monitor entre en contacto con líquidos, límpielo inmediatamente con un paño seco.
- Si se derrama líquido en los orificios de ventilación, no use más el monitor. Póngase en contacto con un técnico de servicio profesional.

Aviso legal:



Los términos HDMI, HDMI High-Definition Multimedia Interface y el logotipo de HDMI son marcas comerciales o marcas registradas de HDMI Licensing, Administrator, Inc. en EE. UU. y otros países.

3. Contenido de la caja



1 x monitor

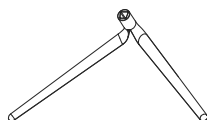

1 x base del pedestal

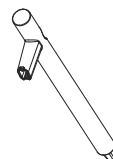

1 x tubo del pedestal

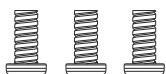

3xPM4x12 tornillo
(para la instalación del pedestal)



2xM4x12/2xM4x9mm
tornillo hexagonal
(para la instalación en pared)



1 x cubierta del tubo

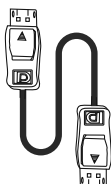

1 x Cable DP

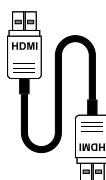

1 x Cable HDMI

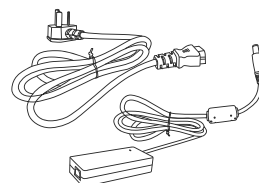

1 x Cable de alimentación
1 x Adaptador de alimentación

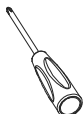

1 x destornillador



1x Manual del usuario

 Se pueden incluir tornillos adicionales de repuesto.

4. INFORMACIÓN GENERAL DEL PRODUCTO

4.1 Botones del monitor

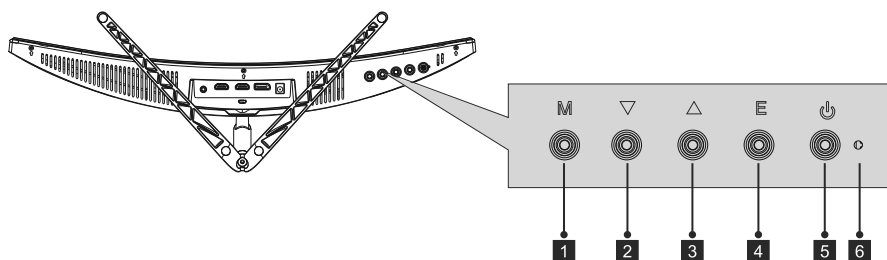

1. Botón Menú: presione este botón para mostrar los menús OSD o introducir los submenús.
2. Botón Abajo: presione este botón para desplazarse hacia abajo por los menús.
3. Botón Arriba: presione este botón para desplazarse hacia arriba por los menús.
4. Botón Salir: presione este botón para salir del menú.
5. Botón de alimentación: presione este botón para encender o apagar el monitor.
6. Indicador LED: cambia de color para indicar el estado del monitor.

4.2 Puertos del monitor

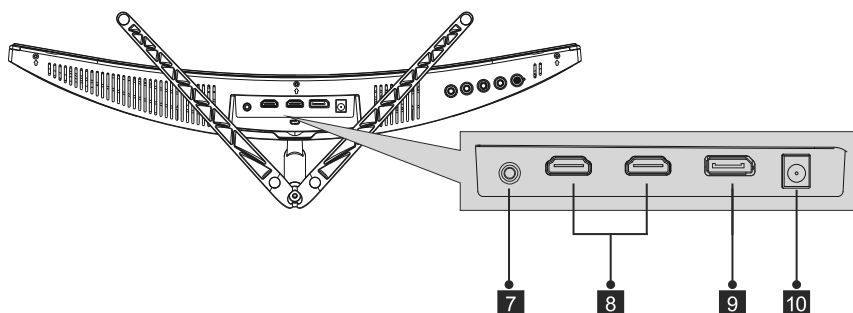

7. Salida de audio: conecte los auriculares o altavoces para reproducir señales de audio desde el equipo.
8. Conectores HDMI: conecte un cable HDMI a uno de estos puertos y al puerto HDMI del equipo (por ejemplo, tarjeta gráfica o placa base).
9. Conector DP: conecte el cable DisplayPort a este puerto y al puerto DisplayPort del equipo (por ejemplo, tarjeta gráfica o placa base).
10. Conector de alimentación: conecte el cable adaptador al monitor y a una toma de corriente.

 Si utiliza otros cables DP o HDMI, asegúrese de que sean compatibles con los estándares más recientes para lograr la mejor calidad de imagen y frecuencia de actualización.

5. INSTALACIÓN DEL PEDESTAL

-  Mantenga la espuma debajo del monitor antes de acoplar el pedestal.
1. Abra el paquete y saque el producto con la espuma todavía acoplada. Colóquelo con cuidado sobre un escritorio o una mesa y proteja la pantalla.

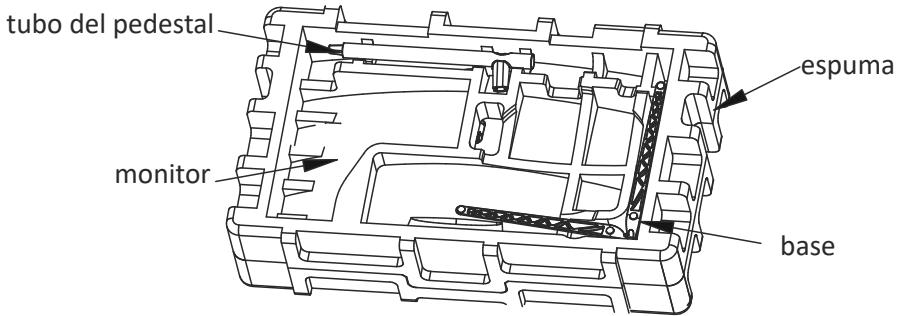

2. Empuje la base en el pedestal y móntela con un tornillo M4.

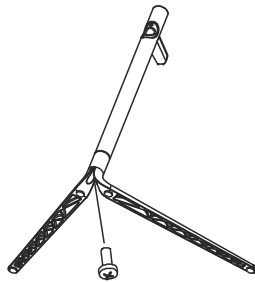

3. Retire la protección de la parte superior de la pantalla y coloque el monitor sobre una superficie plana.

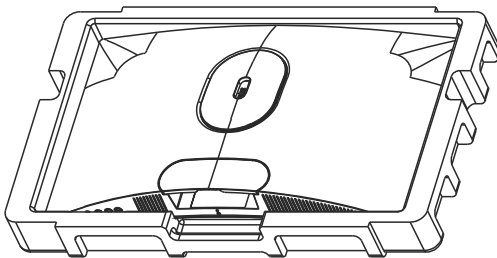

4. Utilice un tornillo M4 para acoplar el pedestal al monitor.

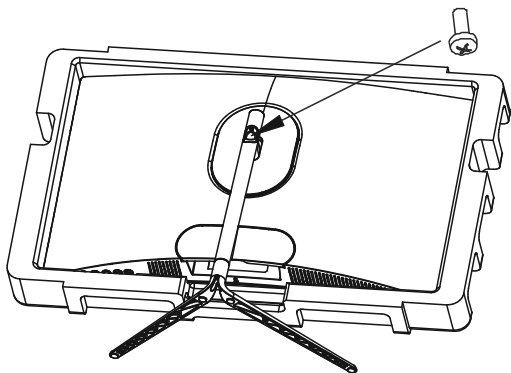

5. Monte la cubierta del tubo en el tubo para cubrir el tornillo.

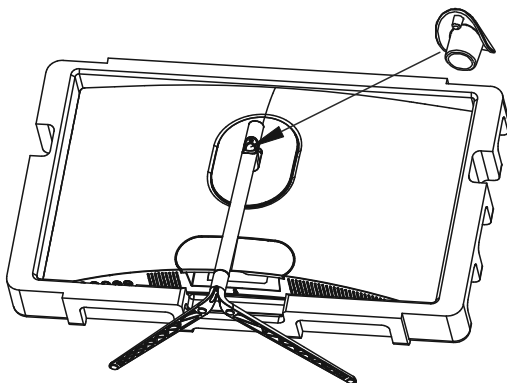

6. La instalación del pedestal se habrá completado.

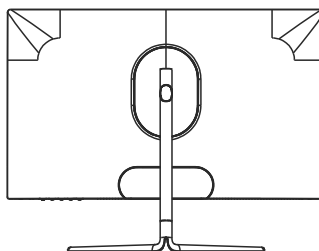
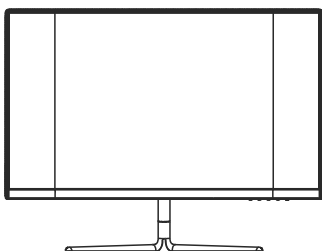

-  Mantenga la parte de espuma unida al monitor mientras lo instala. Para evitar daños, no toque la pantalla.

6. Instalación el soporte para pared

1. Abra el paquete y saque el producto con la espuma todavía acoplada. Colóquelo con cuidado sobre un escritorio o una mesa y proteja la pantalla. Presione el botón de liberación para extraer el pedestal. Si el pedestal ya está montado, retírelo según las indicaciones del capítulo 5.4.

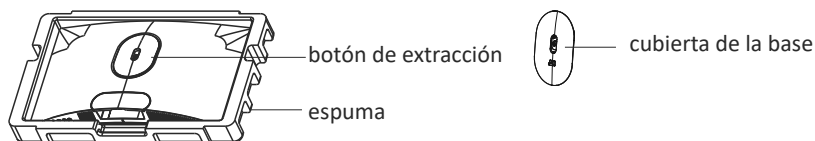

2. Mantenga la espuma debajo del panel para evitar que se rompa. Retire los cuatro tornillos originales de la abertura de la parte posterior del monitor (1).

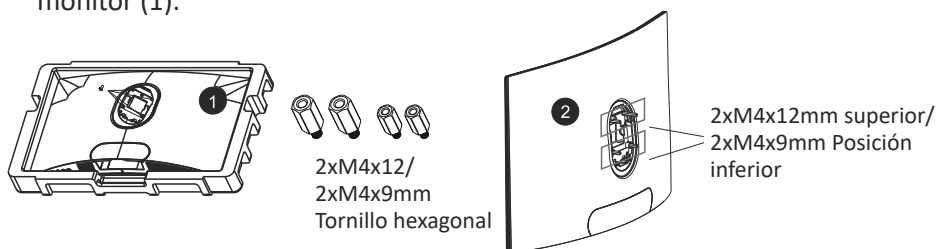

3. Monte los cuatro tornillos hexagonales: xM4x12 mm en la parte superior y 2xM4x9 mm en la posición inferior (2).
4. Siga las instrucciones del soporte para pared o de un accesorio similar para montar el monitor en él.

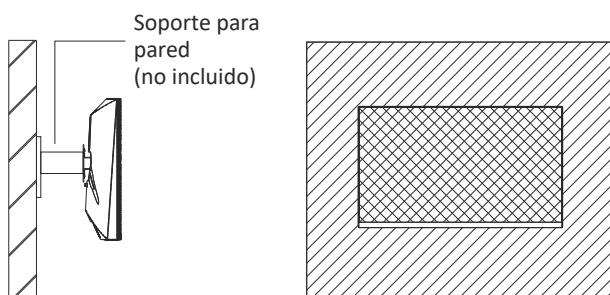

-  Para evitar que se rompa, no toque el panel durante el proceso de montaje. Guarde los tornillos por si desea montar el soporte más adelante.

7. Opciones de conectividad

7.1 Conectar los auriculares

Enchufe los auriculares para recibir señales de audio del equipo. Si los auriculares están conectados al monitor, otros dispositivos de audio, como los altavoces, se silenciarán. Los auriculares u otros dispositivos de audio no están incluidos en la entrega.

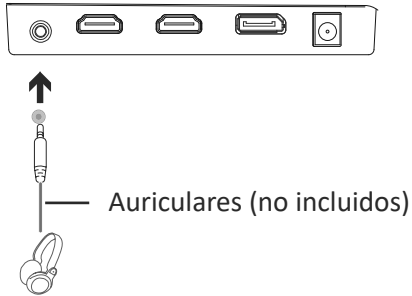

Tenga cuidado, escuchar audio con un volumen elevado durante más tiempo puede dañar permanentemente su audición.

7.2. Conectar el cable de alimentación

Tenga cuidado, escuchar audio con un volumen elevado durante más tiempo puede dañar permanentemente su audición.

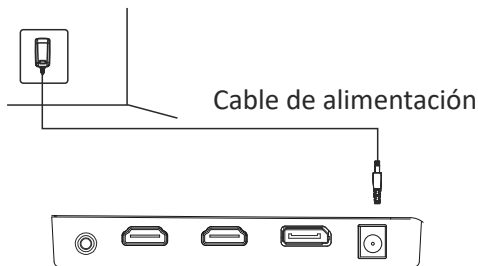

7.3 Conectividad DP

Utilice un cable DP para conectar el monitor al equipo.

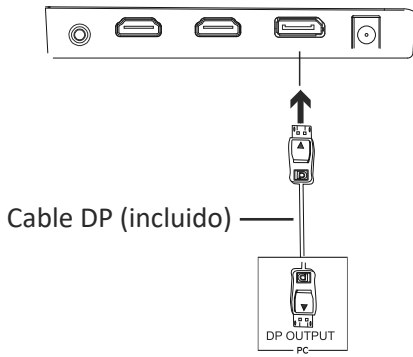

7.4 Conectividad HDMI

Use el cable HDMI para conectar el monitor al equipo en caso de que no disponga de un puerto DP.

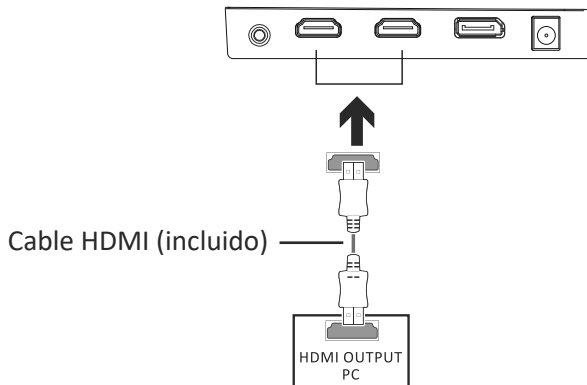

8. Funcionamiento básico

1. Utilice el cable DP para conectar el monitor y la tarjeta gráfica del equipo.
2. Si la tarjeta gráfica no ofrece DP, puede usar el cable HDMI en su lugar.

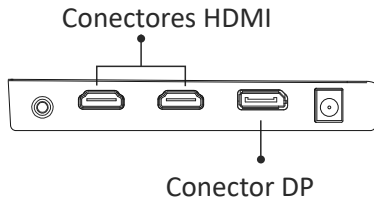

3. Conecte el cable de alimentación al monitor y a una toma de corriente. En caso de que no pueda llegar a una toma de corriente directamente, le recomendamos que utilice un protector contra sobretensiones con el voltaje adecuado.
4. Presione el botón de alimentación del monitor para encenderlo.

9. Indicador luminoso

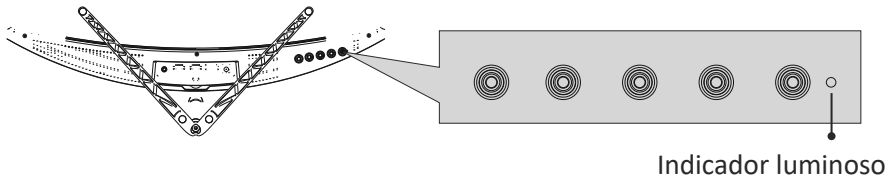

La luz azul constante indica que el monitor está encendido y funcionando con normalidad. La luz azul intermitente indica que no se ha detectado ninguna fuente de vídeo (señal horizontal o vertical). Asegúrese de que el equipo esté encendido y que el cable DP o HDMI esté conectado correctamente (completamente insertado en el puerto).

10. MENÚ OSD

El menú de visualización en pantalla (OSD) se puede usar para ajustar la configuración del monitor y aparece en la pantalla después de encender el monitor y presionar el botón de menú (consulte el capítulo 4.1).

☒ Si usa el monitor por primera vez, la configuración se ajustará automáticamente a la configuración del equipo. Utilice el menú OSD y el software de la tarjeta gráfica para cambiar la configuración según sus necesidades.

1. Presione cualquier botón para activar la ventana de navegación (**M**, **▼**, **▲**, **E**, **🔌**).



2. Presione **M** (🏠) para entrar en el menú OSD.

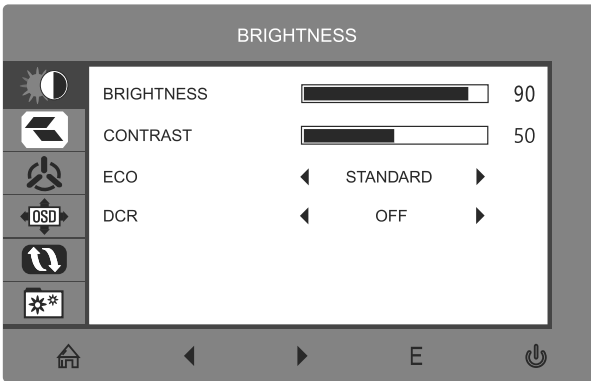

3. Presione **▼** o **▲** para examinar las funciones del menú OSD. Resalte la función que desee y, a continuación, presione **M** para entrar en el submenú. Presione **▼** o **▲** para navegar por los submenús y, a continuación, presione **M** para resaltar la función deseada. Presione **▼** o **▲** para resaltar una opción y, a continuación, presione **M** para confirmar la configuración y salir de la pantalla actual.
4. Presione **E** para salir de la pantalla actual y el menú OSD.

10.1 Funciones de los menús OSD

Menú principal	Submenú	Opciones	Descripción
BRILLO	Brillo	0-100	Permite ajustar el brillo de la pantalla
	Contraste	0-100	Permite ajustar el contraste de la pantalla
	ECO	Estándar, Juego, RTS, FPS, Película, Texto	Establecer el modo visual
	DCR	Activado	Permite activar la función DCR
Desactivado		Permite desactivar la función DCR	
IMAGEN	Aspecto	Panorámica, Automático, 4:3	Permite establecer relación de aspecto
	Temperatura de color	Cálida, Usuario, Fría	Ajuste la temperatura de color
	Rojo	0~100	Permite personalizar componentes RGB
	Verde	0~100	
	Azul	0~100	
CONFIGURACIÓN OSD	Idioma	English , Español , Русский , Français , 한글 , Português , Deutsch , Türkçe , 简体中文 , Polski , Italiano , Nederlands , 日本語	Permite establecer el idioma de los menús OSD
	POS. H. OSD	0~100	Permite ajustar la posición horizontal de los menús OSD
	POS. V. OSD	0~100	Permite ajustar la posición vertical de los menús OSD
	Temporizador de OSD	0~60	Permite establecer cuánto tiempo permanecerán abiertos los menús OSD después de que haya dejado de utilizarse
	Transparencia	0~100	Permite establecer la transparencia global de los menús OSD
Restablecer	Ajuste automático de la imagen	N/D	Establezca el ajuste automático de la pantalla
	Ajuste automático del color	N/D	Establezca el ajuste automático del color de la pantalla
	Restablecer	N/D	Permite restablecer las configuraciones del monitor
	MPRT	Activado, Desactivado	Tiempo de respuesta de imagen en movimiento
VARIOS	Fuente de señal	DP, HDMI1, HDMI2	Permite mostrar la señal de entrada
	Volumen	0-100	Permite ajustar el volumen de audio
	Rayo azul bajo	0-100	Permite establecer nivel de filtrado de luz azul
	Adaptive-Sync	Activado, Desactivado	Permite activar y desactivar la función Adaptive-Sync
	SOBRECONTROLADOR	Alto, Medio, Bajo, Desactivado	Permite establecer la función Sobrecontrolador.
	Efecto LED	Normal, Parpadeo, Desactivado	Permite establecer el modo de visualización de LED.

11. Cambio a los modos ECO y Gameplus

1. Presione cualquier botón para activar la ventana de navegación (M, ▼, ▲, E, ⏻).



2. Presione el botón ▼ para cambiar al modo Gameplus. Elija el icono de juego que mejor se adapte a su juego. Estos iconos de juegos están diseñados principalmente para mejorar su puntería en juegos de disparo, pero, por supuesto, también se pueden usar para otros escenarios.



3. Presione ▲ para cambiar los modos de visualización de LED o desactivar los efectos de LED.



12. Especificaciones técnicas

Modelo	LC-M24-FHD-165-C
Tamaño de la pantalla	23,6"/59,94 cm
Relación de aspecto	16:9
Luz de fondo	E-LED
Brillo	250 cd/m ² (valor típico)
Panel	VA
Resolución	DP 1.2:1920 x 1080 a 165 Hz HDMI1.4:1920 x 1080 a 120 Hz
Tasa de actualización	165 Hz
Tiempo de respuesta	OD4 ms
Ángulo de visión	≥178° (H)≥ 178° (V)
Relación de contraste	3000:1
Soporte VESA	75x75 mm
Colores	16,7 millones
Adaptive-Sync	Sí
Señal de entrada	1 x DP1.2, 2 x HDMI1.4
Altavoces	No incluidos
Cable de alimentación de salida de audio, cable DP, Cable HDMI, luz azul baja, sin parpadeo	Incluido

LC-POWER™

Silent power Electronics GmbH

Formerweg 8

47877 Willich

Germany

www.lc-power.com